

Italy-Spain co-operation 1999-2000

Technical Report UPR/UCa_01_2001

Measurements of breaking waves and bores through a USD velocity profiler

S. Longo, I.J. Losada, M. Petti, N. Pasotti, J.L. Lara

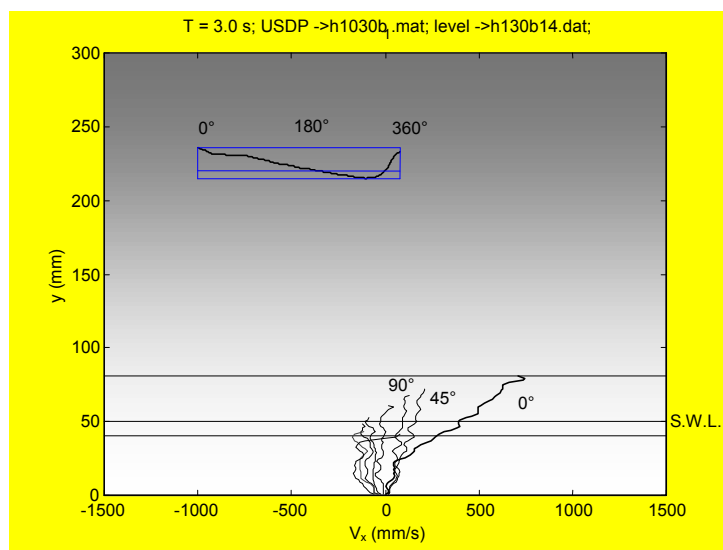

Department of Civil Engineering
University of Parma, Italy

E.T.S.I.C.C. y P.
Ocean & Coastal Research Group Laboratory
Universidad de Cantabria, Spain

March 2001

co-sponsored by
Ministero dell'Università e della
Ricerca Scientifica (MURST), Italy
Ministerio de Educación y Cultura,
Spain

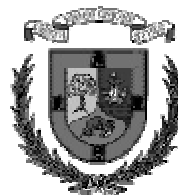

REPORT SUMMARY

1. Background and scope of the experiments	7
2. Framework and execution of the study	7
3. Experimental set-up	8
4. Imposed and measured parameters	9
5. Experimental conditions and test programme	9
6. Data analysis	10
7. Conclusion	11
8. Acknowledgements	12
9. General and uncited references	12
10. References	13

APPENDIX

A1. Average operators	
A2. Characteristics of the instrument	
A3. Characteristics of the probes	
A4. Volume of measurement	
A5. Sources of errors	

Annex 1

Fig. A1- 1 Characteristics of the used US probe.	
Fig. A1- 2 Set-up of a single US probe	
Fig. A1- 3 Set-up of three probes	
Fig. A1- 4 Set-up of three probes (down view)	
Fig. A1- 5 Lay out of the flume.	
Fig. A1- 6 Sections of measurements.	

Tab. A1 - 1 DOP 1000 configuration for measurements in Sec. A. Tab. A1 - 2
DOP 1000 configuration for measurements in Sec. B.

Tab. A1 - 3 DOP 1000 configuration for measurements in Sec. C. Tab. A1 - 4
Measuring programme series I.

Tab. A1 - 5 Measuring programme series II (cont.).

Tab. A1 - 6 Measuring programme series III (cont.).

Tab. A1 - 7 Measuring programme series IV (cont.)

Tab. A1 - 8 Measuring programme Laser series Ia.

Tab. A1 - 9 Measuring programme Laser series Ib	
Tab. A1 - 10 Series I	
Tab. A1 - 11 Series II.....	
Tab. A1 - 12 Series III.....	
Tab. A1 - 13 Series IV (cont.).....	

Annex 2

Average water level. Section 1 and 2. T=2.0 s	
<i>Series I-T=2.0 s</i>	
Average water level. Section 3 (A) and 4 (B). T=2.0 s	
<i>Series I-T=2.0 s</i>	
Average water level. Section 5 (C). T=2.0 s.....	
<i>Series I-T=2.0 s</i>	
Average water level. Section 1 and 2. T=2.0 s	
<i>Series II-T=2.0 s</i>	
Average water level. Section 3 (A) and 4 (B). T=2.0 s	
<i>Series II-T=2.0 s</i>	
Average water level. Section 5 (C). T=2.0 s.....	
<i>Series II-T=2.0 s</i>	
Average water level. Section 1 and 2. T=2.5 s	
<i>Series II-T=2.5 s</i>	
Average water level. Section 3 (A) and 4 (B). T=2.5 s	
<i>Series II-T=2.5 s</i>	
Average water level. Section 5 (C). T=2.5 s.....	
<i>Series II-T=2.5 s</i>	
Average water level. Section 1 and 2. T=3.0 s	
<i>Series II-T=3.0 s</i>	
Average water level. Section 3 (A) and 4 (B). T=3.0 s	
<i>Series II-T=3.0 s</i>	
Average water level. Section 5 (C). T=3.0 s.....	
<i>Series II-T=3.0 s</i>	
Average water level. Section 1 and 2. T=2.0 s	
<i>Series III-T=2.0 s</i>	
Average water level. Section 3 (A) and 4 (B). T=2.0 s	
<i>Series III-T=2.0 s</i>	
Average water level. Section 1 and 2. T=2.5 s	
<i>Series III-T=2.5 s</i>	
Average water level. Section 3 (A) and 4 (B). T=2.5 s	
<i>Series III-T=2.5 s</i>	
Average water level. Section 1 and 2. T=3.0 s	
<i>Series III-T=3.0 s</i>	

Average water level. Section 3 (A) and 4 (B). T=3.0 s
Series III-T=3.0 s

Average water level. Section 1 and 2. T=2.0 s
Series IV-T=2.0 s

Average water level. Section 3 (A) and 4 (B). T=2.0 s
Series IV-T=2.0 s

Average water level. Section 1 and 2. T=2.5 s
Series IV-T=2.5 s

Average water level. Section 3 (A) and 4 (B). T=2.5 s
Series IV-T=2.5 s

Average water level. Section 1 and 2. T=3.0 s
Series IV-T=3.0 s

Average water level. Section 3 (A) and 4 (B). T=3.0 s
Series IV-T=3.0 s

Noise evaluation in Section A.
Series IV

Noise evaluation in Section B.
Series IV

Noise evaluation in Section C.
Series IV

Horizontal velocity profiles. Sections A and B. T=2.0 s
Series IV-T=2.0 s

Horizontal velocity profiles. Sections A and B. T=2.5 s
Series IV-T=2.5 s

Horizontal velocity profiles. Sections A and B. T=3.0 s
Series IV-T=3.0 s

Phasic and mean velocity profiles. Section A. T=2.0 s
Series IV-T=2.0 s

Phasic and mean velocity profiles. Section B. T=2.0 s
Series IV-T=2.0 s

Phasic and mean velocity profiles. Section A and B. T=2.5 s
Series IV-T=2.5 s

Phasic and mean velocity profiles. Section A. T=3.0 s
Series IV-T=3.0 s

Phasic and mean velocity profiles. Section B. T=3.0 s
Series IV-T=3.0 s

Laser measurements phase average velocities at different levels. Each curve
has been shifted upward by 0.1 with respect to the previous.
Laser series

Laser measurements phase average fluctuations at different levels. Each
curve has been shifted upward by 0.01 with respect to the previous.
Laser series

Phase average Reynold's stress at different levels. Each curve has been shifted upward by 0.001 with respect to the previous.

Laser series

Laser measurements. Velocity profiles. T=3.0 s

Laser series

Annex 3

List and structure of data files

1. Background and scope of the experiments

Fluid velocity measurements under waves and bores are essential to validate existing models or to build up new models. Laser Doppler Velocimetry (LDV) is widely used with several limitations due to bubble presence if breaking occurs. Also Hot Wire and Hot Film anemometry is often used in the labs, as well as Particle Image Velocimetry (PIV) with good results and with several other limitations.

The present experiments are focused on the study of the time dependent velocity in breaking waves and subsequent bores in shallow water using a relatively recent technique based on ultrasound. Velocity profiles parallel and orthogonal to the bottom are measured using a Doppler Ultrasonic Technique.

The experimental research was carried out in June and July 2000.

The data have been validated and partially elaborated, and are available for a more detailed verification of the technique in unsteady free surface flows.

2. Framework and execution of the study

The experimental investigation was part of the Italy-Spain 2000 Co-operation programme and was funded by the Ministero dell'Università e delle Ricerche Scientifica (MURST), Italy, and by the Ministerio de Educación y Cultura, Spain.

The experiments were carried out in the small channel of the Ocean & Coastal Research Group Laboratory, E.T.S.I.C.C. y P., Universidad de Cantabria in Santander, Spain, in the weeks from 10th June to 7th July 2000.

The experiment execution and data analysis was conducted by the following research team:

Sandro Longo, University of Parma, Italy
Marco Petti, University of Udine, Italy
Nicoletta Pasotti, University of Udine, Italy

Inigo Losada, University of Santander, Spain
Javier Lopez Lara, University of Santander, Spain

3. Experimental set-up

The experiments were carried out in the small flume in the laboratory of the Ocean and Coastal Research Group at the Universidad de Cantabria of Santander. In Fig.A1-5 and Fig. A1-6 (Annex 1) the general outline of the flume and the measurement sections are shown.

Different apparatus were used in the experiments, as follows:

- Wave flume with wave paddle.
- Control and acquisition data equipment.
- Water level gauges.
- Laser Doppler Velocimeter.
- Digital video camera.
- Digital photographic camera.

The wave flume is 24.00 m long, 0.58 m wide and 0.80 m deep. Glass sidewalls and bottom of the tank are distributed in 20.00 m, to have a visual access to the wave development.

Waves were generated with a piston type paddle with AWACS (Active Wave Absorption Control System) to correct reflected waves. The paddle is made of stainless steel moved by a hydraulic piston. Its frontal surface is covered with a 10 mm thick PVC plate, where two water surface gauges are located to identify water surface elevation. Its technical characteristics are:

- Inertial mass: 20 N s²/m.
- Maximum horizontal stroke: 1000 mm.
- Frontal surface: 0.58 m².
- Width: 0.58 m.
- Height: 0.995 m.
- Maximum strength: 5031 N.
- Oil-hydraulic group power: 10 KW.

Paddle generation program and data acquisition procedure used have been developed by the Coastal and Ocean Research group. This procedure includes wave generation and gauges calibration procedure. Data have been store in a PC computer where a digital-analogic board is incorporated.

Firstly, a plastic glass false bottom has been installed in the wave tank to create a uniform slope of 1 on 20. The still water depth in the constant-depth region of the tank was 0.4 m in most experiments. The slope has been sealed to the tank walls filling the gap between the edges of the slope and the sidewalls with silicone.

DHI resistive type water level gauges were located on an instrument platform, which can slide along the top of the tank on two rails.

A DANTEC LDV (Laser Doppler Velocimeter) was used to take velocity measurements. It is a backscatter, four-beams system with a 6 W ion-argon laser generator refrigerated by water. A 30.00 m optical fiber carries laser beams from an optical system to the measurements location, where it is fixed into a two dimensional programmable transverse system. Data were also stored in a PC computer.

A Ultrasound Doppler Velocity Profiler DOP1000 (www.signal-processing.com) was used to take velocity measurements in three sections, with three probes per section.

4. Imposed and measured parameters

Several combinations of sinusoidal waves were realised in the flume by imposing a required piston movement.

The following parameters were measured:

- Water level in five sections
- Water velocity in three sections using USDP
- Water velocity in one section using LDV.

The frequency of acquisition was equal to 180 Hz for water level, from ~10 to ~30 Hz (~10 to ~30 velocity profiles per second) for USDP, varying for LDV (data were stored with frequency related to the occurrence of validated burst), with maximum value around 2 kHz.

The data were originally stored in ASCII format for the water level gauges, ASCII format for LDV and in binary format for the DOP1000. After a preliminary elaboration, the latter are also available in binary Matlab® files form.

5. Experimental conditions and test programme

The experimental programme consisted of three different period sinusoidal waves and two wave height. The still water level in the horizontal bottom part of the flume varies from 40 cm to 36 cm, in order to obtain wave breaking in the first section of measurement of the fluid velocity. The generated waves are linear or corrected to the 5th order. A long wave absorbing system is active during wave generation.

Tests carried out were:

Series I

5th order waves, single wave period $T=2.0$ s, wave height $H=12$ cm, still water level = 40 cm. Fluid velocity measurements through UDVP in three sections.

Series II

Linear waves, three wave periods $T=2.0; 2.5; 3.0$ s, $H=12$ cm, s.w.l.=40 cm. Fluid velocity measurements through UDVP in three sections.

Series III

5th order waves, three wave periods $T=2.0; 2.5; 3.0$ s, $H=10$ cm, s.w.l.=37 cm. Fluid velocity measurements through UDVP in three sections.

Series IV

5th order waves, three wave periods $T=2.0; 2.5; 3.0$ s, $H=10$ cm, s.w.l.=36 cm. Fluid velocity measurements through UDVP in two sections.

Laser Series

5th order waves, three wave periods $T=3.0$ s, $H=10$ cm, s.w.l.=37 cm. Fluid velocity measurements through UDVP in one sections. 2-D LDV measurements in 21 points in the vertical of one section.

6. Data analysis

Data have been analysed in the time domain. Water level elevation measured by the 5 probes (except for a subset of tests where the last probe was dry most of the time), UDVP velocity profiles and LDV measurements have been averaged in phase using a Variable Time Interval Average (VITA) in order to obtain their evolution during one period. The VITA requires a trigger event. It has been chosen as the instant of maximum water level. Moreover only those short time series lasting for a time equal to $T \pm 0.02T$ have been selected and averaged.

The results are reported in Annex 2. The dashed lines represent the maximum and minimum level recorded and thus a measurement of the variance. The variance is modest for non-breaking waves, recorded in Sec.1 and 2, and strongly increases after breaking (subsequent sections).

The UDVP velocity profiles, obtained applying the techniques reported in Appendix, have been averaged in phase choosing as first profile in the period the nearest to the instant of trigger (the instant of maximum water level in the section).

The results are reported in Annex II only for the Measurement Series IV, characterised by the maximum data rate of UDVP (≈ 30 profiles per second per

each probe). Also AVI files have been obtained containing the animation of velocity profiles.

UDVP velocity profiles have been also time averaged in order to obtain the mean fluid velocity. The classical undertow is evident in all sections.

The aim of LDV measurements was the comparison of results with those obtained through USDP. Unfortunately the USDP signal was useless during Laser Series. Anyway the LDV data have been analysed.

Phase averaged velocity profiles were calculated at each level from the bottom in Section 3 (A). Turbulent oscillations $u'(y,t)$ along the main flow direction have been obtained by subtracting the phase-averaged value $\tilde{u}(y,t)$ from the instantaneous velocity measured $u(y,t)$:

$$\begin{aligned} u'(y,t) &= u(y,t) - \tilde{u}(y,t) \\ v'(y,t) &= v(y,t) - \tilde{v}(y,t) \end{aligned} \quad (1)$$

The phase averaged values were obtained using a VITA technique triggering to the maximum horizontal velocity.

The phase average horizontal and vertical velocity and turbulent fluctuations are reported in Annex II. Also the cross product $\widetilde{u'v'}$ profiles are reported for the 20 useful levels over the bottom where LDV measurements took place.

7. Conclusion

UDVP technique has several advantages respect to other fluid velocity measurements. It can give information on spatio-temporal velocity, with data rate virtually independent on seeding concentration. It can also be used in opaque fluids. The error is strictly related to the accuracy of set-up, and can be reduced to less than 5%.

The present limits are essentially due to the low data rate, which allows at most macro-turbulence measurements. The low data rate is intrinsic in the carrier celerity, around 1000 m/s. The system has the disadvantage of no data validation, and of a large volume of measurements, although this last limit can be eliminated using some focussed probes. The absence of data validation can generate error due to aliasing: if the Doppler frequency is out of the bandwidth, the spectrum is aliasized and the estimated velocity is not correct. It is an important limit in high turbulence flows.

In the flow field analysed in the present experimental activity, the instrument had good performances especially in situations where LDV measurements are not useful, as in bores after breaking.

8. Acknowledgements

This work is undertaken as part of Italy-Spain Co-operation Project, 2000. Nicoletta Pasotti has also partially been supported by MAST III - SASME Project ("Surf and Swash Zone Mechanics") founded by the Commission of the European Communities, Directorate General Research and Development under contract no. MAS3-CT97-0081. We wish to express our thanks to the technicians and to the staff of the Ocean & Coastal Research Group Laboratory, in Santander, for their valuable collaboration in carrying out experiments.

9. General and uncited references

- Antoine, Y. And Lebouché, M., 1998. Détermination de vitesses de glissement lors de l'écoulement d'une suspension non newtonienne par utilisation de la vélocimétrie ultrasonore à effet Doppler. C.R.Acad.Sci. Paris, t.326, Série II b, p. 367-372.
- Austin, J.C. and Challis, R.E., 1999. Ultrasonic propagation through aqueous kaolin suspensions during degassing. *Ultrasonics*, 37:299-302.
- Battjes, J. A and Sakai, T., 1980. Velocity field in a steady breaker. *J. Fluid Mech.* 111: 421-437.
- Costigan, G. and Whalley, P.B., 1997. Measurements of the speed of sound in air-water flows. *Chem. Engineering Journal*, 66: 131-135.
- Hinze, J.O., 1975. *Turbulence*. McGraw-Hill series in mechanical engineering.
- Inoue, Y., Yamashita, S. and Kumada, M., 1999. An experimental study on a wake behind a torus using the UVP monitor. *Exp. In Fluids*, 26: 197-207.
- Kikura, H., Takeda, Y. And Durst, F., 1999. Velocity profile measurement of the Taylor vortex flow of a magnetic fluid using the ultrasonic Doppler method. *Exp. In Fluids*, 26: 208-214.
- Laborde, J.-L., Hita, A., Caltagirone, J.-P. and Gerard, A., 2000. Fluid dynamics phenomena induced by power ultrasounds. *Ultrasonics*, 38: 297-300.
- Lemmin, U. and Rolland, T., 1997. Acoustic velocity profiler for laboratory and field studies. *J. of Hydraulic Engineering*, Vol. 123, No. 12, pp. 1089-1098.
- Marcos, A.-G., 1999. Etude d'un Vélocimètre Doppler Ultrasonore (Signal Preprocessing) pour son utilisation en canal à houle. Master Report, Groupe Mécanique des Fluides & Génie Côtier, D.E.A. Énergétique et Aérothermochimie Option Combustion et Moteur, Université de Caen, France (in french).
- Nielsen, K.D., Weber, L.J. and Muste, M., 1999. Capabilities and limits for ADV measurements in bubbly flows. XXVIII IAHR Congress, Graz.
- Papoulis, A., 1965. *Probability, random variables and stochastic problems*. McGraw-Hill, NY.
- Peschard, I., Le Gal, P. and Takeda, Y., 1999. On the spatio-temporal structure of cylinder wakes. *Exp. In Fluids*, 26: 188-196.

- Petti, M., Longo, S., Sadun, S. and Tirindelli, M., 1998. Swash zone hydrodynamics on a 1:10 bottom slope: laboratory data. SASME Report FIUD-01-98, Univ.of Florence.
- Signal Processing, 1998. Manual for DOP1000.
- Rodriguez, A., Sanchez-Arcilla, A., Redondo, J.M. and Mosso, C., 1999. Macroturbulence measurements with electromagnetic and ultrasonic sensors: a comparison under high-turbulent flows. *Exp. In Fluids*, 27: 31-42.
- Rolland, T. and Lemmin, U., 1997. A two-component acoustic velocity profiler for use in turbulent open channel flow. *J. of Hydraulic Research*, Vol. 35, No. 4, pp. 545-561.
- Schouveiler, L., Le Gal, P., Chauve, M.P. and Takeda, Y., 1999. Spiral and circular waves in the flow between a rotating and a stationary disk. *Exp. In Fluids*, 26: 179-187.
- Wunderlich, Th. And Brunn, P.O., 2000. A wall layer correction for ultrasound measurement in tube flow: comparison between theory and experiment. *Flow Meas. and Instrum.*, 11: 63-69.
- Wunderlich, Th. And Brunn, P.O., 1999. Ultrasound pulse Doppler method as viscometer for process monitoring. *Flow Meas. and Instr.*, 10, pp. 201-205.
- Wunenburger, R., Andreotti, B. and Petitjeans, P., 1999. Influence of precession on velocity measurements in a strong laboratory vortex. *Exp. In Fluids*, 27: 181-188.

10. References

- Blackwelder, R.F. and Kaplan, R.E., 1976. On the wall structure of the turbulent boundary layer. *J. Fluid Mech.*, 76, 80-112.
- Kikura, H., Takeda, Y. And Durst, F., 1999. Velocity profile measurement of the Taylor vortex flow of a magnetic fluid using the ultrasonic Doppler method. *Exp. In Fluids*, 26: 208-214.
- Nikora, V.I. and Goring, D.G., 1998. ADV measurements of turbulence: can we improve their interpretation ?. *J. of Hydraulic Engineering*, Vol. 124, No. 6, pp. 630-634.
- Petti, M. and Longo, S., 2001. Turbulence experiments in the swash zone. *Coast. Engineering*, Vol.43-1, pp.1-24.
- Takeda, Y., 1999. Ultrasonic Doppler method for velocity profile measurement in fluid dynamics and fluid engineering. *Exp. In Fluids*, 26: 177-178.

APPENDIX

A1. Average operators4

A2. Characteristics of the instrument5

A3. Characteristics of the probes.....5

A4. Volume of measurement.....5

A5. Sources of errors6

A1. Average operators

There are several operators used for periodic signals. The ensemble or phase average $\bar{\mathbf{h}}(t)$ of a time series is expressed as:

$$\bar{\mathbf{h}}(t) = \frac{1}{N} \sum_{k=0}^{N-1} \mathbf{h}(t + kT) \quad 0 \leq t < T \quad (\text{A1})$$

where $\mathbf{h}(t)$ represents instantaneous values, N is the number of waves in the chosen time interval and T is the period. This operator is highly sensitive to small fluctuations of the period, due for example to a frequency modulating effect.

If a well-identified trigger is available, the conditional average is expressed as:

$$\bar{\mathbf{h}}(t) = \frac{1}{N} \sum_{k=0}^{N-1} \mathbf{h}(t + t_k) \quad 0 \leq t < \min(T) \quad (\text{A2})$$

where t_k is the instant of trigger of the k -cycle and $\min(T)$ is the minimum time period in the series of N cycles. The conditional average is widely known as the Variable Interval Time Average (VITA, see Blackwelder and Kaplan, 1976). A more correct and unbiased result can be obtained stretching the data of each cycle (the time period of each cycle, equal to $(t_k - t_{k-1})$ is not constant) before averaging in order to extend it all over the mean period. Such a technique is equivalent to the demodulation process in the time-domain of a weak-modulated (in frequency) signal (Petti and Longo, 2001).

If the value of time series is not defined during some time intervals (e.g. Eulerian fluid velocity is strictly related to mass presence in the point of measurements, and is not defined during mass absence) we can define a phasic average:

$$\bar{\mathbf{h}} = \frac{\sum_i \int_{\Delta T_i} \mathbf{h}(t) dt}{\sum_i \Delta T_i} \quad (\text{A3})$$

where ΔT_i are the time steps during water presence. This last operator is particularly important in the analyses of our data because in some sections of measurements the water is often absent.

For completeness, the well-known time average operator is reported:

$$\langle \mathbf{h} \rangle = \frac{1}{T} \int_0^T \mathbf{h}(t) dt, \quad (\text{A4})$$

with T the period of time averaging.

All the above-defined operators are linear and can be applied in sequence without rank.

A2. Characteristics of the instrument

DOP1000 is an instrument for the measurement of fluid velocity in several measuring volumes along the beam of a piezo-electric transducer, working as emitter and receiver. It is based on pulsed ultrasonic Doppler effect. The source of signal is pressure wave generated by an emitter with frequency ranging from 1 to 10 MHz. The signal scattered by seeding particles and/or eddies is elaborated to detect particle position using the travel time of the signal and the echo, and particle velocity using the frequency shift of the echo. This technique has some major advantages respect to traditional techniques (e.g. Laser Doppler Velocimetry LDV, Particle Image Velocimetry PIV, Electro Magnetic Flowmeter EMF), as the spatio-temporal information about the flow field. See Takeda, 1999, for accurate description of these advantages.

A3. Characteristics of the probes

The source of pressure waves is a piezo electric quartz transducer driven by electronics. The pressure field is strictly related to the geometry of the transducer. In general it is possible to distinguish a near field, (Fresnel zone) where the acoustic field is cylindrical (if the source probe is circular) and a far field where the acoustic field has several lobes. See Fig. A1-1.

The probes used are piezoelectric transducers working at 1 MHz with plastic housing 18 mm in diameter and active element diameter of 14 mm. The near field extends for 32 mm and the divergence angle is 15° . The ultrasonic beam passing through plexiglass modify its path, due to refraction in the medium having different acoustic impedance.

To investigate a 2-D flow fields, at least two probes have to be set-up; usually three probes are used. See Fig.A1-2 for the single probe arrangement and Fig. A1-3 for the three probes set-up.

A4. Volume of measurement

For the probe we used, the near field is 32 mm wide, and the total angle of divergence is of 15° . This behaviour generates relatively wide and thin volumes of measurements, enlarged far from the probe.

The volume of measurement depends on the probe characteristics.

A5. Sources of errors

Several tests on performances of ADV (measurement of three velocity components in a single volume) are available. The main source of errors, especially in turbulence measurements, is the Doppler noise. It is probably due to multiple particles or micro eddies present in the volume of measurement, which scatter echoes broadening the spectral peak. Tests conducted by Nikora and Goring, 1998, give the following main results:

Spectra and probability distributions indicate that Doppler noise is essentially a Gaussian white noise.

Doppler noise depends on the seeding particles, and is higher for bubbles.

The two Authors also suggest a technique to estimate the Doppler noise influence on turbulent characteristics, based on measuring Doppler signal with the instrument set-up in the same condition of the experiment (same velocity range, pulse repetition frequency etc.) but in still water having the same seeding characteristics of the water used in the experiments. The two velocity components can be expressed as a function of the velocity measured along the beams and of their noise:

$$(u, v) = f(u_i, N_i) \quad (\text{A5})$$

with f determined by the geometry of the probes, u_i are the true values of the velocity components along the i -beam and N_i is the noise along the i -beam. The transformation can be written as:

$$\begin{Bmatrix} u \\ v \end{Bmatrix} = \mathbf{A} \begin{Bmatrix} u_1 + N_1 \\ u_2 + N_2 \end{Bmatrix} \quad (\text{A6})$$

The expected values are simply:

$$\begin{Bmatrix} \langle u \rangle \\ \langle v \rangle \end{Bmatrix} = \mathbf{A} \begin{Bmatrix} \langle u_1 \rangle + \langle N_1 \rangle \\ \langle u_2 \rangle + \langle N_2 \rangle \end{Bmatrix} \quad (\text{A7})$$

and the estimated variances are:

$$\begin{Bmatrix} \langle u'^2 \rangle \\ \langle v'^2 \rangle \end{Bmatrix} = \mathbf{A} \begin{Bmatrix} \langle u_1'^2 \rangle + \langle N_1'^2 \rangle \\ \langle u_2'^2 \rangle + \langle N_2'^2 \rangle \end{Bmatrix} \quad (\text{A8})$$

under the hypothesis that the velocity-noise correlation are zero. The estimators of the true components can be obtained as:

$$\begin{aligned} \langle u_i \rangle &= \langle u_{im} \rangle - \langle N_i \rangle \\ \langle u_i'^2 \rangle &= \langle u_{im}'^2 \rangle - \langle N_i'^2 \rangle \end{aligned} \quad (\text{A9})$$

where the subscript m indicates the measured value.

The mean errors and the error variances have been computed for homogeneous conditions of acquisition (same spatial resolution, PRF) in still water conditions, and are reported in Annex 2.

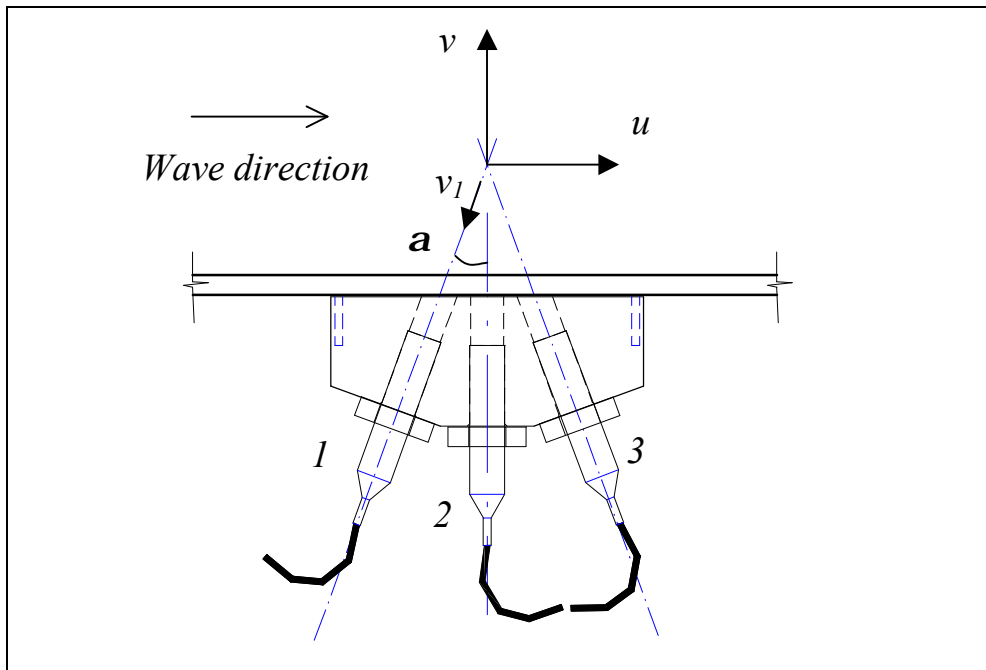

Fig. App.1. Reference system

The velocity components in x and y directions can be obtained measuring velocity components along the beam axes (see reference system):

$$\begin{aligned} u_1 &= -u \sin \mathbf{a} - v \cos \mathbf{a} \\ u_3 &= u \sin \mathbf{a} - v \cos \mathbf{a} \\ u_2 &= -v \end{aligned} \quad (\text{A10})$$

The system is over constrained. The minimum error is obtained using the first two relationships to determine the u component, and the third relationship for the

vertical velocity component. Similar transformations can be obtained for the variances:

$$\begin{aligned}\widetilde{u'v'} &= \frac{\widetilde{u_1'^2} - \widetilde{u_3'^2}}{\sin 2\mathbf{a}} \\ \widetilde{u'^2} &= \frac{\widetilde{u_1'^2} + \widetilde{u_3'^2} - 2\widetilde{u_2'^2} \cos^2 \mathbf{a}}{2 \sin^2 \mathbf{a}} \\ \widetilde{v'^2} &= \widetilde{u_2'^2}\end{aligned}\tag{A11}$$

The measured noise and its STD has been computed in the three sections and are reported in Annex 2.

A N N E X 1

Fig. A1- 1 Characteristics of the used US probe.....	7
Fig. A1- 2 Set-up of a single US probe.....	8
Fig. A1- 3 Set-up of three probes.....	9
Fig. A1- 4 Set-up of three probes (down view).....	10
Fig. A1- 5 Lay out of the flume.	12
Fig. A1- 6 Sections of measurements.	12
Tab. A1 - 1 DOP 1000 configuration for measurements in Sec. A.	4
Tab. A1 - 2 DOP 1000 configuration for measurements in Sec. B.	5
Tab. A1 - 3 DOP 1000 configuration for measurements in Sec. C.	6
Tab. A1 - 4 Measuring programme series I.	13
Tab. A1 - 5 Measuring programme series II (cont.).....	14
Tab. A1 - 6 Measuring programme series III (cont.).....	16
Tab. A1 - 7 Measuring programme series IV (cont.).....	18
Tab. A1 - 8 Measuring programme Laser series Ia.....	20
Tab. A1 - 9 Measuring programme Laser series Ib.	21
Tab. A1 - 10 Series I.....	22
Tab. A1 - 11 Series II.....	23
Tab. A1 - 12 Series III.....	24
Tab. A1 - 13 Series IV (cont.).....	25

DOP1000 version	5.23
Data type	Velocity
Emitting frequency	1.0 MHz
Emitting power	Medium
Pulse repetition frequency	3125 Hz, 320 μ s, 240 mm
Burst length	8 cycles
Resolution	2.0 μ s, 1.50 mm
Sensitivity	Medium
Number of emission pro profiles	64 31.2 ms
Doppler scale factor	2
Maximum velocity	1171.50 mm/s
Minimum velocity	-1171.50 mm/s
Velocity offset (coded and in mm/s) ...	0 0 mm/s
Memory size	20000 624000 ms
Number of bytes pro profile	164
Skip profile	0 .0 ms
Number of channels	154
First channel at0 μ s, .0 mm
First recorded channel	1 .0 μ s, .0 mm
Last recorded channel	154 306.0 μ s, 229.5 mm
Anterior wall at channel	8 14.0 μ s, 10.5 mm
Posterior wall at channel	10 18.0 μ s, 13.5 mm
Cursor at channel	10 18.0 μ s, 13.5 mm
Selected filter type	none
Zero values	included
Number of profiles used for filtering .	2
FFT channel position	19 28.5
FFT window	Hamming
FFT number of points	128
Unit	US axis
Doppler angle	0 degrees
Sound velocity	1500 m/s
TGC mode	slope
TGC start value	18 dB
TGC end value	40 dB
Trigger	On
Trigger mode	Waiting for +
Trigger delay	0 .0 ms
Number of profiles pro sequences	20000 624000 s
Number of sequences	1
Multiplexer	Multiplex on
Recorded profiles on transducer 1	1 31.2 ms
Recorded profiles on transducer 2	1 31.2 ms
Recorded profiles on transducer 3	1 31.2 ms

Tab. A1 - 1 DOP 1000 configuration for measurements in Sec. A.

DOP1000 version	5.23
Data type	Velocity
Emitting frequency	1.0 MHz
Emitting power	medium
Pulse repetition frequency	2906 Hz,344 μ s,258 mm
Burst length	8 cycles
Resolution	2.0 μ s,1.50 mm
Sensitivity	medium
Number of emission pro profiles	64 33.1 ms
Doppler scale factor	2
Maximum velocity	1089.75 mm/s
Minimum velocity	-1089.75 mm/s
Velocity offset (coded and in mm/s) ...	0 0 mm/s
Memory size	20000 662000 ms
Number of bytes pro profile	176
Skip profile	0 .0 ms
Number of channels	166
First channel at0 μ s,.0 mm
First recorded channel	1 .0 μ s,.0 mm
Last recorded channel.....	166 330.0 μ s,247.5 mm
Anterior wall at channel	8 14.0 μ s,10.5 mm
Posterior wall at channel	10 18.0 μ s,13.5 mm
Cursor at channel	10 18.0 μ s,13.5 mm
Selected filter type	none
Zero values	included
Number of profiles used for filtering .	2
FFT channel position	19 28.5
FFT window	Hamming
FFT number of points	128
Unit	US axis
Doppler angle	0 degrees
Sound velocity.....	1500 m/s
TGC mode	slope
TGC start value	14 dB
TGC end value	40 dB
Trigger	On
Trigger mode	Waiting for +
Trigger delay	0 .0 ms
Number of profiles pro sequences	20000 662000 s
Number of sequences	1
Multiplexer	Multiplex on
Recorded profiles on transducer 1	1 33.1 ms
Recorded profiles on transducer 2	1 33.1 ms
Recorded profiles on transducer 3	1 33.1 ms

Tab. A1 - 2 DOP 1000 configuration for measurements in Sec. B.

DOP1000 version	5.23
Data type	Velocity
Emitting frequency	1.0 MHz
Emitting power	Medium
Pulse repetition frequency	3125 Hz,320 μ s,240 mm
Burst length	8 cycles
Resolution	1.0 μ s,.75 mm
Sensitivity	Medium
Number of emission pro profiles	64 31.2 ms
Doppler scale factor	2
Maximum velocity	1171.50 mm/s
Minimum velocity	-1171.50 mm/s
Velocity offset (coded and in mm/s) ...	0 0 mm/s
Memory size	20000 624000 ms
Number of bytes pro profile	234
Skip profile	0 .0 ms
Number of channels	224
First channel at0 μ s,.0 mm
First recorded channel	1 .0 μ s,.0 mm
Last recorded channel.....	224 223.0 μ s,167.2 mm
Anterior wall at channel	8 7.0 μ s,5.2 mm
Posterior wall at channel	10 9.0 μ s,6.7 mm
Cursor at channel	10 9.0 μ s,6.7 mm
Selected filter type	None
Zero values	Included
Number of profiles used for filtering .	2
FFT channel position	19 14.2
FFT window	Hamming
FFT number of points	128
Unit	US axis
Doppler angle	0 degrees
Sound velocity.....	1500 m/s
TGC mode	slope
TGC start value	-3 dB
TGC end value	40 dB
Trigger	On
Trigger mode	Waiting for +
Trigger delay	0 .0 ms
Number of profiles pro sequences	20000 624000 s
Number of sequences	1
Multiplexer	Multiplex on
Recorded profiles on transducer 1	1 31.2 ms
Recorded profiles on transducer 2	1 31.2 ms
Recorded profiles on transducer 3	1 31.2 ms

Tab. A1 - 3 DOP 1000 configuration for measurements in Sec. C.

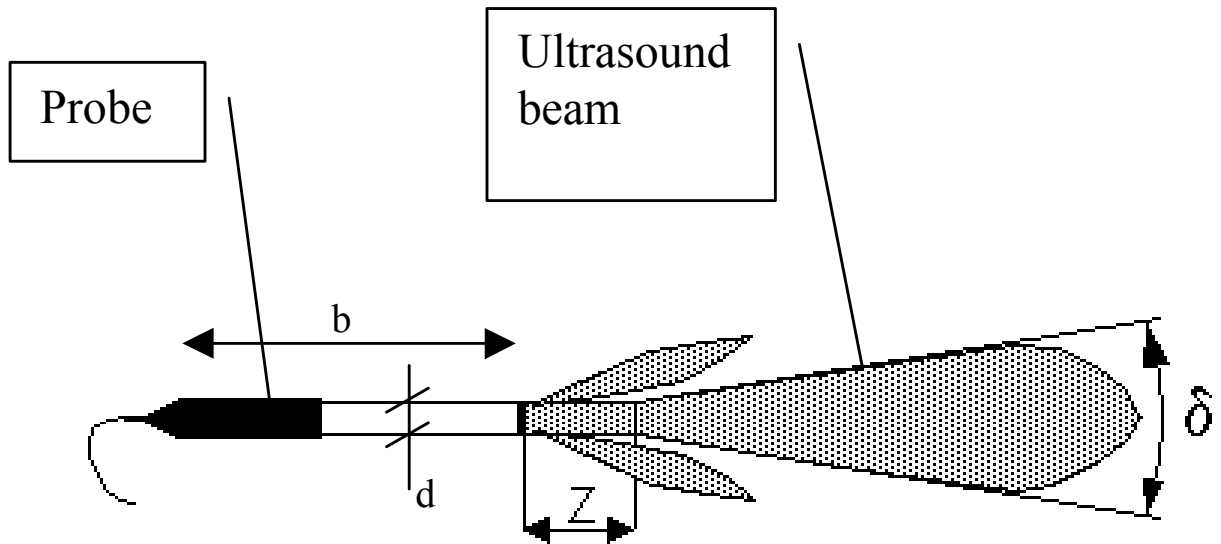

Frequency (MHz)	Piezo diameter (mm)	Plastic housing d (mm)	b (mm)	Near field Z (mm)	Divergence degrees
1	14	18	76	32	15

Fig. A1- 1 Characteristics of the used US probe.

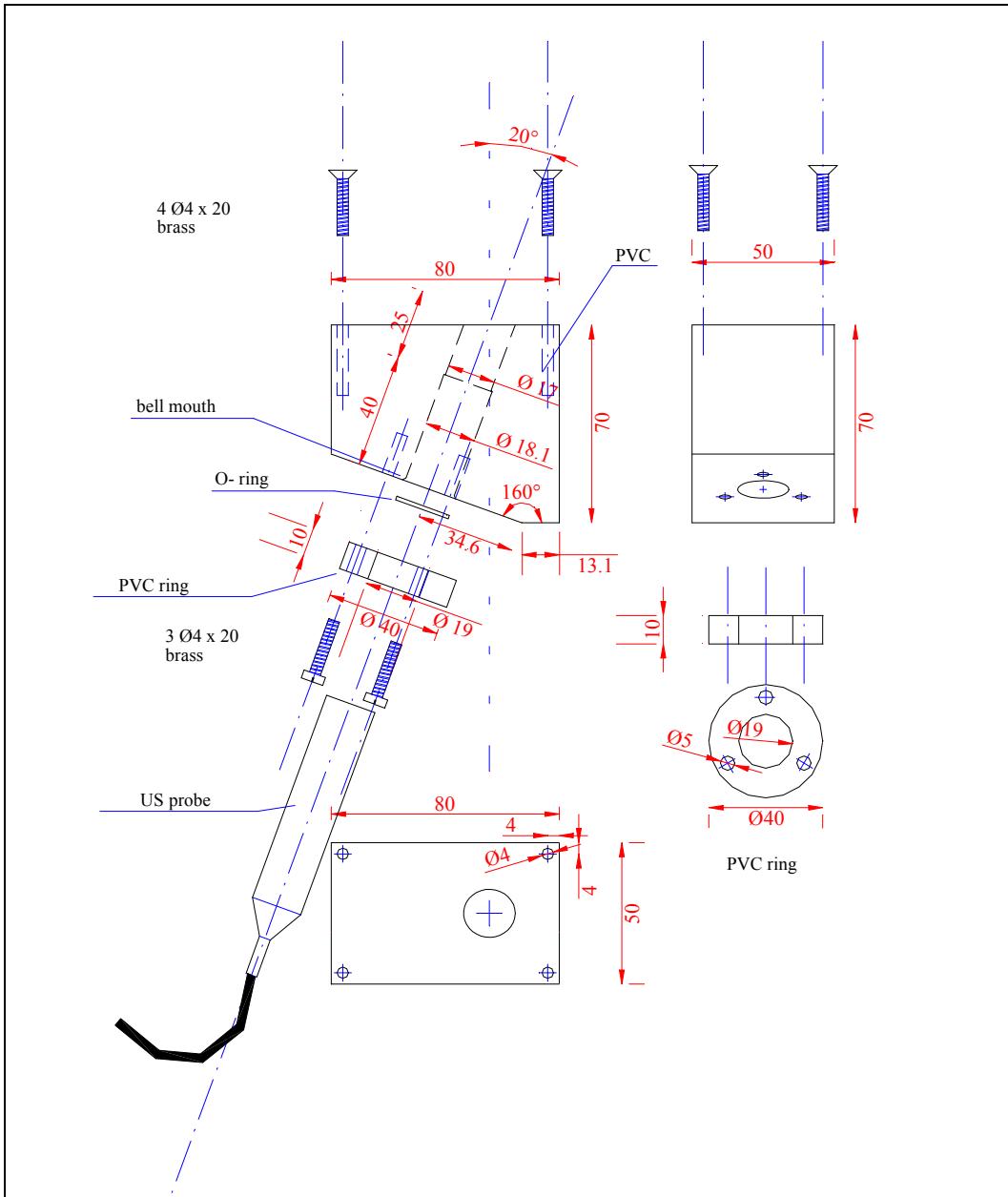

Fig. A1- 2 Set-up of a single US probe.

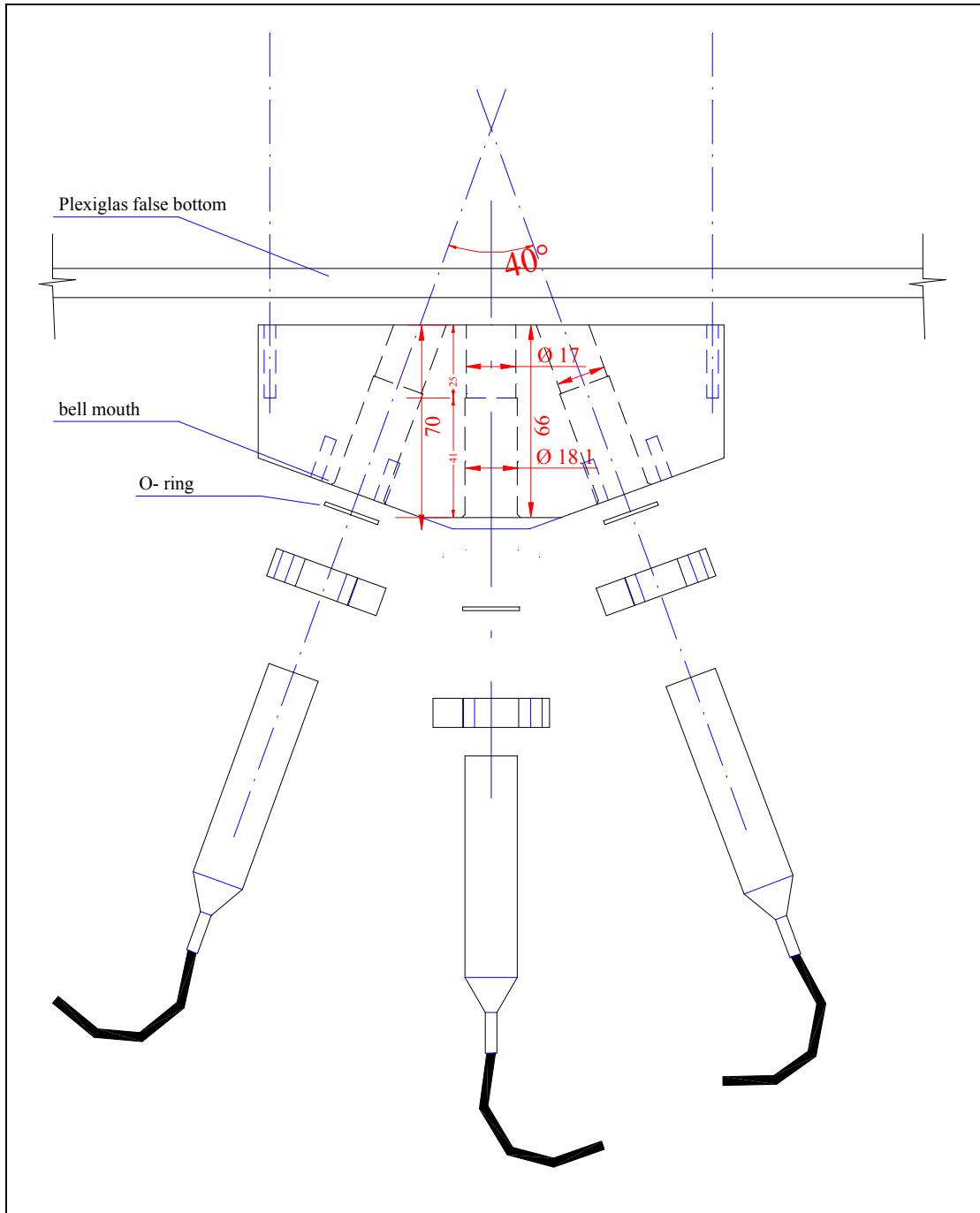

Fig. A1- 3 Set-up of three probes.

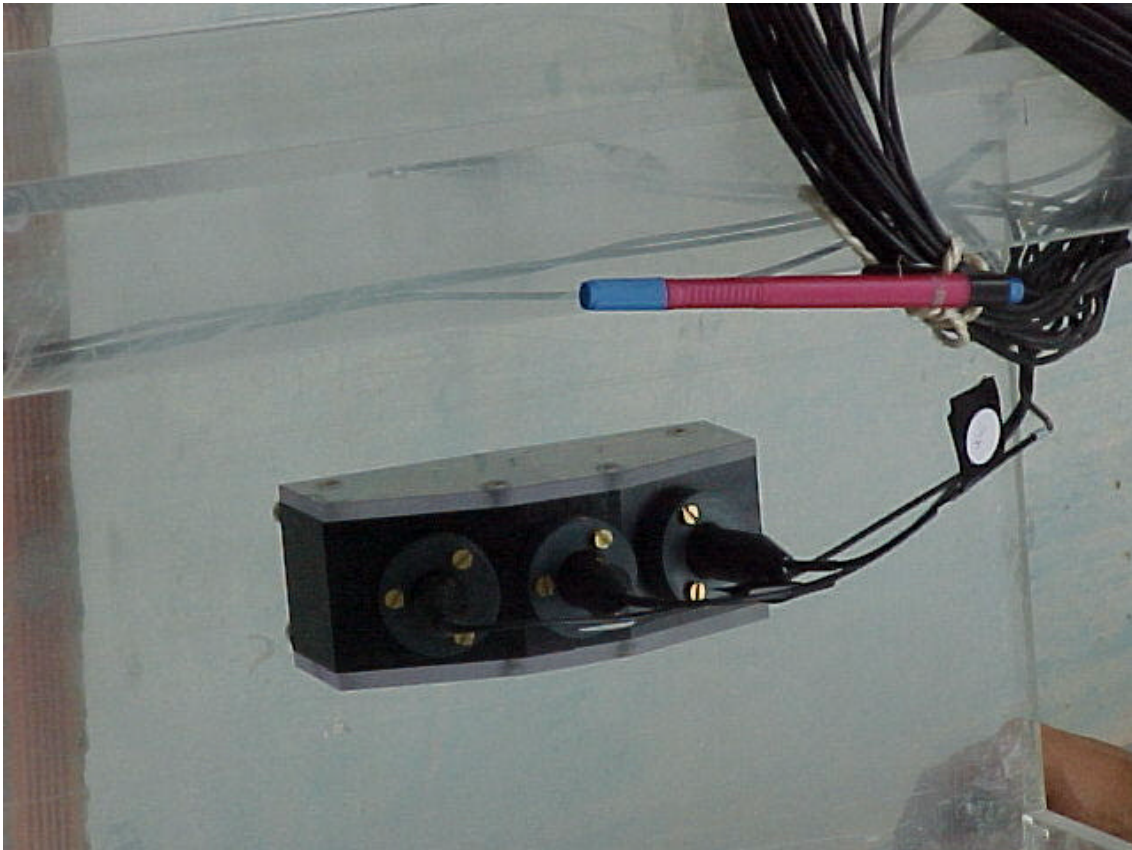

Fig. A1- 4 Set-up of three probes (down view).

UPr
UCa

Measurements of breaking waves and bores through a USD velocity profiler. Annex 1

A1 - 11

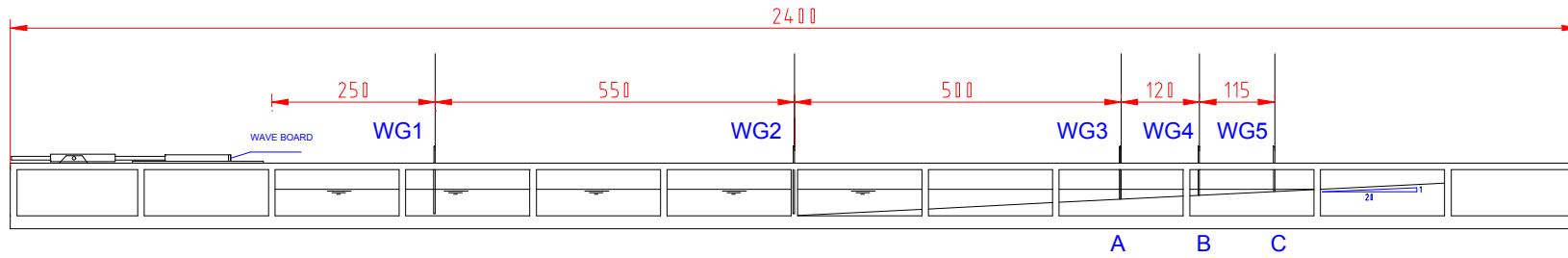

Fig. A1- 5 Lay out of the flume.

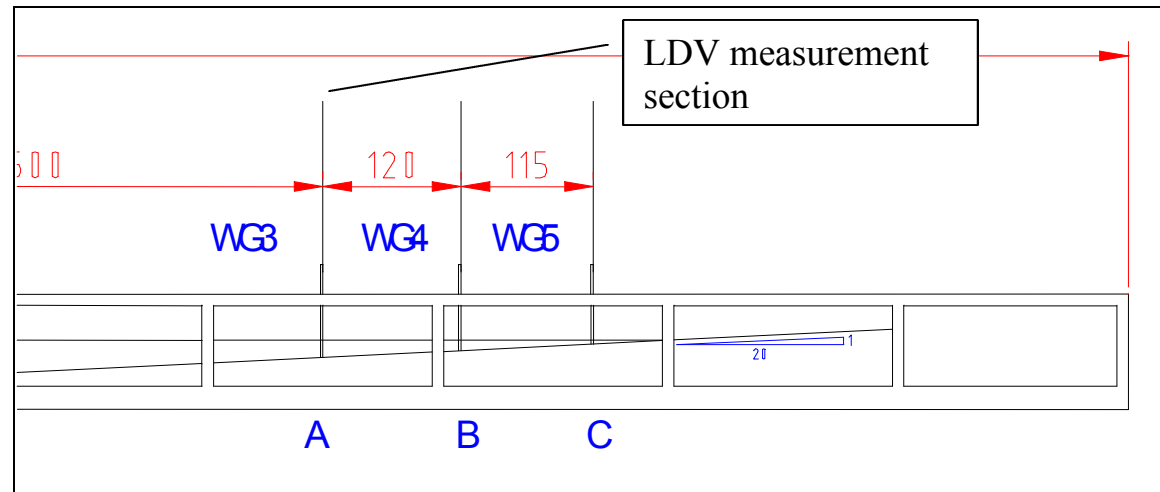

Fig. A1- 6 Sections of measurements.

Water level elevation files									
date	Test (UDVP file)	condition	WG1	WG2	WG3 sec. A	WG4 sec. B	WG5 sec. C	description	Remarks:
		H=12 cm T=2.0 s 5 th order generation waves	2.5	8.0	13.0	14.2	15.35	distance from the paddle (m)	
			40	40	15	9	3.3	still water depth (cm)	
26.6.2000	H1220a		H1220a1.dat	H1220a2.dat	<u>H1220a3.dat</u>	H1220a4.dat	H1220a5.dat	velocity meas. in section A	
27.6.2000	H1220b		H1220b1.dat	H1220b2.dat	H1220b3.dat	<u>H1220b4.dat</u>	H1220b5.dat	velocity meas. in section B	
27.6.2000	H1220c		H1220c1.dat	H1220c2.dat	H1220c3.dat	H1220c4.dat	<u>H1220c5.dat</u>	velocity meas. in section C	
26.6.2000			LIV0011.dat	LIV0012.dat	LIV0013.dat	LIV0014.dat	LIV0015.dat	zero calibration	
26.6.2000			ca260600.cal					calibration file	
27.6.2000			LEV0021.dat	LEV0022.dat	LEV0023.dat	LEV0024.dat	LEV0025.dat	zero calibration	
27.6.2000			ca270600.cal					calibration file	

Tab. A1 - 4 Measuring programme series I.

UPr
UCa

Measurements of breaking waves and bores through a USD velocity profiler. Annex 1.

date	test (UDVP file)	condition	Water level elevation files					description	Remarks:
			WG1	WG2	WG3 sec. A	WG4 sec. B	WG5 sec. C		
		H=12 cm	2.5	8.0	13.0	14.2	15.35	distance from the paddle (m)	
		linear generation waves	40	40	15	9	3.3	still water depth (cm)	
27.6.2000	L1220a	T=2.0 s	L11220a1.dat	L11220a2.dat	L11220a3.dat	L11220a4.dat	L11220a5.dat	velocity meas. in section A	UDVP not useful
30.6.2000	L1220a_2		L1220a1.dat	L1220a2.dat	<u>L1220a3.dat</u>	L1220a4.dat	L1220a5.dat	velocity meas. in section A	substitutes L1220a
28.6.2000	L1220b		L1220b1.dat	L1220b2.dat	L1220b3.dat	<u>L1220b4.dat</u>	L1220b5.dat	velocity meas. in section B	
28.6.2000	L1220c		L1220c1.dat	L1220c2.dat	L1220c3.dat	L1220c4.dat	<u>L1220c5.dat</u>	velocity meas. in section C	
27.6.2000	L1225a	T=2.5 s	L1225a1.dat	L1225a2.dat	<u>L1225a3.dat</u>	L1225a4.dat	L1225a5.dat	velocity meas. in section A	
28.6.2000	L1225b		L1225b1.dat	L1225b2.dat	L1225b3.dat	<u>L1225b4.dat</u>	L1225b5.dat	velocity meas. in section B	
28.6.2000	L1225c		L1225c1.dat	L1225c2.dat	L1225c3.dat	L1225c4.dat	<u>L1225c5.dat</u>	velocity meas. in section C	

Tab. A1 - 5 Measuring programme series II (cont.).

			Water level elevation files						
date	test (UDVP file)	condition	WG1	WG2	WG3 sec. A	WG4 sec. B	WG5 sec. C	description	Remarks:
		H=12 cm	2.5	8.0	13.0	14.2	15.35	distance from the paddle (m)	
		linear generation waves	40	40	15	9	3.3	still water depth (cm)	
27.6.2000	L1230a	T=3.0 s	LI1230a1.dat	LI1230a2.dat	LI1230a3.dat	LI1230a4.dat	LI1230a5.dat	velocity meas. in section A	UDVP not useful
30.6.2000	L1230a_2		L1230a1.dat	L1230a2.dat	<u>L1230a3.dat</u>	L1230a4.dat	L1230a5.dat	velocity meas. in section A	substitutes L1230a
28.6.2000	L1230b		L1230b1.dat	L1230b2.dat	L1230b3.dat	<u>L1230b4.dat</u>	L1230b5.dat	velocity meas. in section B	
28.6.2000	L1230c		L1230c1.dat	L1230c2.dat	L1230c3.dat	L1230c4.dat	<u>L1230c5.dat</u>	velocity meas. in section C	
28.6.2000			LIV0031.dat	LIV0032.dat	LIV0033.dat	LIV0034.dat	LIV0035.dat	zero calibration	
28.6.2000			ca280600.cal					calibration file	

Measuring programme series II (cont'd.).

UPr
UCa

Measurements of breaking waves and bores through a USD velocity profiler. Annex 1.

			Water level elevation files						
date	test (UDVP file)	condition	WG1	WG2	WG3 sec. A	WG4 sec. B	WG5 sec. C	description	Remarks:
		H=10 cm	2.5	8.0	13.0	14.2	15.35	distance from the paddle (m)	
		5 th order generation waves	37	37	12	6	0.3	still water depth (cm)	
30.06.2000	H1020a	T=2.0 s	H1020a1.dat	H1020a2.dat	<u>H1020a3.dat</u>	H1020a4.dat	H1020a5.dat	velocity meas. in section A	
30.06.2000	H1020b		H1020b1.dat	H1020b2.dat	H1020b3.dat	<u>H1020b4.dat</u>	H1020b5.dat	velocity meas. in section B	
30.06.2000	H1020c		H1020c1.dat	H1020c2.dat	H1020c3.dat	H1020c4.dat	<u>H1020c5.dat</u>	velocity meas. in section C	
30.06.2000	H1025a	T=2.5 s	H1025a1.dat	H1025a2.dat	<u>H1025a3.dat</u>	H1025a4.dat	H1025a5.dat	velocity meas. in section A	
30.06.2000	H1025b		H1025b1.dat	H1025b2.dat	H1025b3.dat	<u>H1025b4.dat</u>	H1025b5.dat	velocity meas. in section B	
30.06.2000	H1025c		H1025c1.dat	H1025c2.dat	H1025c3.dat	H1025c4.dat	<u>H1025c5.dat</u>	velocity meas. in section C	

Tab. A1 - 6 Measuring programme series III (cont.).

			Water level elevation files						
date	test (UDVP file)	condition	WG1	WG2	WG3 sec. A	WG4 sec. B	WG5 sec. C	description	Remarks:
		H=10 cm	2.5	8.0	13.0	14.2	15.35	distance from the paddle (m)	
		5 th order generation waves	37	37	12	6	0.3	still water depth (cm)	
30.06.2000	H1030a	T=3.0 s	H1030a1.dat	H1030a2.dat	<u>H1030a3.dat</u>	H1030a4.dat	H1030a5.dat	velocity meas. in section A	
30.06.2000	H1030b		H1030b1.dat	H1030b2.dat	H1030b3.dat	<u>H1030b4.dat</u>	H1030b5.dat	velocity meas. in section B	
30.06.2000	H1030c		H1030c1.dat	H1030c2.dat	H1030c3.dat	H1030c4.dat	<u>H1030c5.dat</u>	velocity meas. in section C	
30.06.2000			LIV0051.dat	LIV0052.dat	LIV0053.dat	LIV0054.dat	LIV0055.dat	zero calibration	
30.06.2000			ca300600.cal					calibration file	

Measuring programme series III (cont'd.).

UPr
UCa

Measurements of breaking waves and bores through a USD velocity profiler. Annex 1.

date	test (UDVP file)	condition	Water level elevation files					description	Remarks:
			WG1	WG2	WG3 sec. A	WG4 sec. B	WG5 sec. C		
		H=10 cm	2.5	8.0	13.0	14.2	15.35	distance from the paddle (m)	
		5 th order generation waves	36	36	11	5	-0.7	still water depth (cm)	
05/07/00	H1020a_1	T=2.0 s	H120a11.dat	H120a12.dat	<u>H120a13.dat</u>	H120a14.dat	H120a15.dat	velocity meas. in section A	
05/07/00	H1020a_2		H120a21.dat	H120a22.dat	<u>H120a23.dat</u>	H120a24.dat	H120a25.dat	velocity meas. in section A	
05/07/00	H1020a_3		H120a31.dat	H120a32.dat	<u>H120a33.dat</u>	H120a34.dat	H120a35.dat	velocity meas. in section A	
05/07/00	H1020b_1		H120b11.dat	H120b12.dat	H120b13.dat	<u>H120b14.dat</u>	H120b15.dat	velocity meas. in section B	
05/07/00	H1020b_2		H120b21.dat	H120b22.dat	H120b23.dat	<u>H120b24.dat</u>	H120b25.dat	velocity meas. in section B	
05/07/00	H1025a_1		T=2.5 s	H125a11.dat	H125a12.dat	H125a13.dat	H125a14.dat	H125a15.dat	velocity meas. in section A
05/07/00	H1025a_2	H125a21.dat		H125a22.dat	H125a23.dat	H125a24.dat	H125a25.dat	velocity meas. in section A	UDVP not useful
05/07/00	H1025a_3	H125a31.dat		H125a32.dat	<u>H125a33.dat</u>	H125a34.dat	H125a35.dat	velocity meas. in section A	
05/07/00	H1025b_1	H125b11.dat		H125b12.dat	H125b13.dat	H125b14.dat	H125b15.dat	velocity meas. in section B	UDVP not useful
05/07/00	H1025b_2	H125b21.dat		H125b22.dat	H125b23.dat	<u>H125b24.dat</u>	H125b25.dat	velocity meas. in section B	

Tab. A1 - 7 Measuring programme series IV (cont.).

			Water level elevation files						
date	test (UDVP file)	condition	WG1	WG2	WG3 sec. A	WG4 sec. B	WG5 sec. C	description	Remarks:
		H=10 cm	2.5	8.0	13.0	14.2	15.35	distance from the paddle (m)	
		5 th order generation waves	36	36	11	5	-0.7	still water depth (cm)	
05/07/00	H1030a_1	T=3.0 s	H130a11.dat	H130a12.dat	H130a13.dat	H130a14.dat	H130a15.dat	velocity meas. in section A	UDVP not useful
05/07/00	H1030a_2		H130a21.dat	H130a22.dat	<u>H130a23.dat</u>	H130a24.dat	H130a25.dat	velocity meas. in section A	
05/07/00	H1030a_3		H130a31.dat	H130a32.dat	<u>H130a33.dat</u>	H130a34.dat	H130a35.dat	velocity meas. in section A	
05/07/00	H1030b_1		H130b11.dat	H130b12.dat	H130b13.dat	<u>H130b14.dat</u>	H130b15.dat	velocity meas. in section B	
05/07/00	H1030b_2		H130b21.dat	H130b22.dat	H130b23.dat	<u>H130b24.dat</u>	H130b25.dat	velocity meas. in section B	
05/07/00			LIV0081.dat	LIV0082.dat	LIV0083.dat	LIV0084.dat	LIV0085.dat	zero calibration	
05/07/00		ca050700.cal					calibration file		

Measuring programme series IV (cont'd.).

UPr
UCa

Measurements of breaking waves and bores through a USD velocity profiler. Annex 1.

date	test (UDVP file)	condition	Water level elevation files					description	Remarks:
			WG1	WG2	WG3 sec. A	WG4 sec. B	WG5 sec. C		
		H=10 cm	2.5	8.0	13.0	14.2	15.35	distance from the paddle (m)	
			37	37	12	6	0.3	still water depth (cm)	
04/07/00	H1030a_laser	5 th order generation waves T=3.0 s						velocity meas. in section A laser meas. in sec. A (see below)	UDVP not useful
04/07/00			LIV0071.dat	LIV0072.dat	LIV0073.dat	LIV0074.dat	LIV0075.dat	zero calibration	
04/07/00			ca040700.cal					calibration file	

Tab. A1 - 8 Measuring programme Laser series Ia.

Test	Conditions	duration (min)	Zlaser (mm)	Locking time Vx(%)	locking time Vy(%)	Mass concentration (%)	Remarks:
L1		5	0.5	100	100	100	Water level meas. out of scale

L2	H=10 cm T=3.0 s bottom slope 1 :20 water depth = 120 mm	5	10	100	100	100	Water level meas. out of scale
L3		5	20	100	100	100	Water level meas. out of scale
L4		5	30	100	100	100	Water level meas. out of scale
L5		5	40	100	100	100	Water level meas. out of scale
L6		5	50	100	100	100	Water level meas. out of scale
L7		5	60	100	100	100	Water level meas. out of scale
L8		5	70	93	76	100	Water level meas. out of scale
L9		5	80	74	61	100	Water level meas. out of scale
L10		5	90	40	36	84	Water level meas. out of scale
L11		5	95	36	36	74	Water level meas. out of scale
L12		5	100	31	29	64	Water level meas. out of scale
L13		5	110	24	12	53	Water level meas. out of scale
L14		5	120	10	10	41	Water level meas. out of scale
L15		5	130	8.4	6.9	29	Water level meas. out of scale
L16		5	140	5.5	6.4	20	Water level meas. out of scale
L17		5	150	4.0	3.4	9.7	Water level meas. out of scale
L18		5	160	2.8	3.0	7.8	Water level meas. out of scale
L19		5	170	2.3	2.1	6.3	Water level meas. out of scale
L20		5	180	2.1	3.3	5.0	Water level meas. out of scale

Tab. A1 - 9 Measuring programme Laser series Ib.

UPr
UCa

Measurements of breaking waves and bores through a USD velocity profiler. Annex 1.

date	test		data #	duration (s)	t ^{start} (s)	number of waves	vertical profiles per second	channels (points along the US probe axis)	spatial resol. (mm)	max measured distance from the bottom (mm)	s.w.l. (mm)	m.w.l. (mm)	h _{max} (mm)	h _{min} (mm)
26.6.2000	H1220a	T=2.0 s	5940	518	100	200	11.46	154	1.5	178	150	146	249	114
27.6.2000	H1220b	H=12 cm	6666	625	100	200	10.66	166	1.5	194	90	98	137	80
27.6.2000	H1220c	5 th order	5550	506	100	200	10.97	224	0.75	119	33	47	66	32

Tab. A1 - 10 Series I

date	test		data #	duration (s)	t_{start} (s)	number of waves	vertical profiles per second	channels (points along the US probe axis)	spatial resol. (mm)	max measured distance from the bottom (mm)	s.w.l. (mm)	m.w.l. (mm)	h_{max} (mm)	h_{min} (mm)
30.6.2000	11220a_2	T=2.0 s	6667	582	100	200	11.46	154	1.5	178	150	146	257	111
28.6.2000	11220b	H=12 cm	6667	625	100	200	10.66	166	1.5	194	90	93	137	72
28.6.2000	11220c	linear	5000	456	100	150	10.97	224	0.75	119	33	48	68	34
27.6.2000	11225a	T=2.5 s	6667	582	100	180	11.46	154	1.5	178	150	146	259	104
28.6.2000	11225b	H=12 cm	6667	625	100	180	10.66	166	1.5	194	90	95	128	72
28.6.2000	11225c	linear	5550	506	100	150	10.97	224	0.75	119	33	50	65	37
30.6.2000	11230a	T=3.0 s	6667	582	100	150	11.46	154	1.5	178	150	146	290	114
28.6.2000	11230b	H=12 cm	6667	625	100	180	10.66	166	1.5	194	90	84	118	65
28.6.2000	11230c	linear	5650	515	100	120	10.97	224	0.75	119	33	49	77	32

Tab. A1 - 11 Series II

UPr
UCa

Measurements of breaking waves and bores through a USD velocity profiler. Annex 1.

date	test		data #	duration (s)	t_{start} (s)	number of waves	vertical profiles per second	channels (points along the US probe axis)	spatial resol. (mm)	max measured distance from the bottom (mm)	s.w.l. (mm)	m.w.l. (mm)	h_{max} (mm)	h_{min} (mm)
30.6.2000	H1020a	T=2.0 s	6667	582	100	200	11.46	154	1.5	178	120	117	200	90
30.6.2000	H1020b	H=10 cm	6667	626	100	200	10.66	166	1.5	194	60	66	97	51
30.6.2000	H1020c	5 th order	5650	515	100	200	10.97	224	0.75	119				
30.6.2000	H1025a	T=2.5 s	6667	582	100	150	11.46	154	1.5	178	120	117	217	85
30.6.2000	H1025b	H=10 cm	6667	626	100	150	10.66	166	1.5	194	60	66	96	47
30.6.2000	H1025c	5 th order	5600	511	100	150	10.97	224	0.75	119				
30.6.2000	H1030a	T=3.0 s	6667	582	100	150	11.46	154	1.5	178	120	118	206	86
30.6.2000	H1030b	H=10 cm	6667	626	100	150	10.66	166	1.5	194	60	67	97	45
30.6.2000	H1030c	5 th order	5700	520	100	150	10.97	224	0.75	119				

Tab. A1 - 12 Series III

date	test		data #	duration (s)	t_{start} (s)	number of waves	vertical profiles per second	channels (points along the US probe axis)	spatial resol. (mm)	max measured distance from the bottom (mm)	s.w.l. (mm)	m.w.l. (mm)	h_{max} (mm)	h_{min} (mm)
05.7.2000	H1020a_1	T=2.0 s	6667	224	40	60	29.79	154	1.5	178	110	108	176	82
05.7.2000	H1020a_2	H=10 cm	6667	224	40	60	29.79	154	1.5	178	110	108	177	80
05.7.2000	H1020a_3	5 th order	6667	224	50	60	29.79	154	1.5	178	110	108	177	80
05.7.2000	H1020b_1		6667	241	40	60	27.72	166	1.5	194	50	58	82	45
05.7.2000	H1020b_2		6667	241	40	60	27.72	166	1.5	194	50	58	82	45
05.7.2000	H1025a_3	T=2.5 s	6667	224	40	55	29.79	154	1.5	178	110	108	188	81
05.7.2000	H1025b_2	H=10 cm	6667	241	40	55	27.72	166	1.5	194	50	58	83	41

Tab. A1 - 13 Series IV (cont.)

UPr
UCa

Measurements of breaking waves and bores through a USD velocity profiler. Annex 1.

date	test		data #	duration (s)	t_{start} (s)	number of waves	vertical profiles per second	channels (points along the US probe axis)	spatial resol. (mm)	max measured distance from the bottom (mm)	s.w.l. (mm)	m.w.l. (mm)	h_{max} (mm)	h_{min} (mm)
05.7.2000	H1030a_2	T=3.0 s	6667	224	40	45	29.79	154	1.5	178	110	107	178	76
05.7.2000	H1030a_3	H=10 cm	6667	224	40	45	29.79	154	1.5	178	110	107	178	76
05.7.2000	H1030b_1	5 th order	6667	241	40	45	27.72	166	1.5	194	50	58	80	41
05.7.2000	H1030b_2		6667	241	40	45	27.72	166	1.5	194	50	58	80	40

Series IV (cont'd)

A N N E X 2

Summary

Average water level. Section 1 and 2. T=2.0 s 5
 Series I-T=2.0 s 5
 Average water level. Section 3 (A) and 4 (B). T=2.0 s 6
 Series I-T=2.0 s 6
 Average water level. Section 5 (C). T=2.0 s 7
 Series I-T=2.0 s 7
 Average water level. Section 1 and 2. T=2.0 s 8
 Series II-T=2.0 s 8
 Average water level. Section 3 (A) and 4 (B). T=2.0 s 9
 Series II-T=2.0 s 9
 Average water level. Section 5 (C). T=2.0 s 10
 Series II-T=2.0 s 10
 Average water level. Section 1 and 2. T=2.5 s 11
 Series II-T=2.5 s 11
 Average water level. Section 3 (A) and 4 (B). T=2.5 s 12
 Series II-T=2.5 s 12
 Average water level. Section 5 (C). T=2.5 s 13
 Series II-T=2.5 s 13
 Average water level. Section 1 and 2. T=3.0 s 14
 Series II-T=3.0 s 14
 Average water level. Section 3 (A) and 4 (B). T=3.0 s 15
 Series II-T=3.0 s 15
 Average water level. Section 5 (C). T=3.0 s 16
 Series II-T=3.0 s 16
 Average water level. Section 1 and 2. T=2.0 s 17
 Series III-T=2.0 s 17
 Average water level. Section 3 (A) and 4 (B). T=2.0 s 18
 Series III-T=2.0 s 18
 Average water level. Section 1 and 2. T=2.5 s 19
 Series III-T=2.5 s 19
 Average water level. Section 3 (A) and 4 (B). T=2.5 s 20
 Series III-T=2.5 s 20
 Average water level. Section 1 and 2. T=3.0 s 21
 Series III-T=3.0 s 21
 Average water level. Section 3 (A) and 4 (B). T=3.0 s 22
 Series III-T=3.0 s 22
 Average water level. Section 1 and 2. T=2.0 s 23
 Series IV-T=2.0 s 23
 Average water level. Section 3 (A) and 4 (B). T=2.0 s 24
 Series IV-T=2.0 s 24
 Average water level. Section 1 and 2. T=2.5 s 25
 Series IV-T=2.5 s 25
 Average water level. Section 3 (A) and 4 (B). T=2.5 s 26
 Series IV-T=2.5 s 26

Average water level. Section 1 and 2. T=3.0 s	
Series IV-T=3.0 s	27
Average water level. Section 3 (A) and 4 (B). T=3.0 s	
Series IV-T=3.0 s	28
Noise evaluation in Section A.	
Series IV	29
Noise evaluation in Section B.	
Series IV	30
Noise evaluation in Section C.	
Series IV	31
Horizontal velocity profiles. Sections A and B. T=2.0 s	
Series IV-T=2.0 s	32
Horizontal velocity profiles. Sections A and B. T=2.5 s	
Series IV-T=2.5 s	33
Horizontal velocity profiles. Sections A and B. T=3.0 s	
Series IV-T=3.0 s	34
Phasic and mean velocity profiles. Section A. T=2.0 s	
Series IV-T=2.0 s	35
Phasic and mean velocity profiles. Section B. T=2.0 s	
Series IV-T=2.0 s	36
Phasic and mean velocity profiles. Section A and B. T=2.5 s	
Series IV-T=2.5 s	37
Phasic and mean velocity profiles. Section A. T=3.0 s	
Series IV-T=3.0 s	38
Phasic and mean velocity profiles. Section B. T=3.0 s	
Series IV-T=3.0 s	39
Laser measurements phase average velocities at different levels. Each curve has been shifted upward by 0.1 with respect to the previous.	
Laser series	40
Laser measurements phase average fluctuations at different levels. Each curve has been shifted upward by 0.01 with respect to the previous.	
Laser series	41
Phase average Reynold's stress at different levels. Each curve has been shifted upward by 0.001 with respect to the previous.	
Laser series	42
Laser measurements. Velocity profiles. T=3.0 s	
Laser series	43

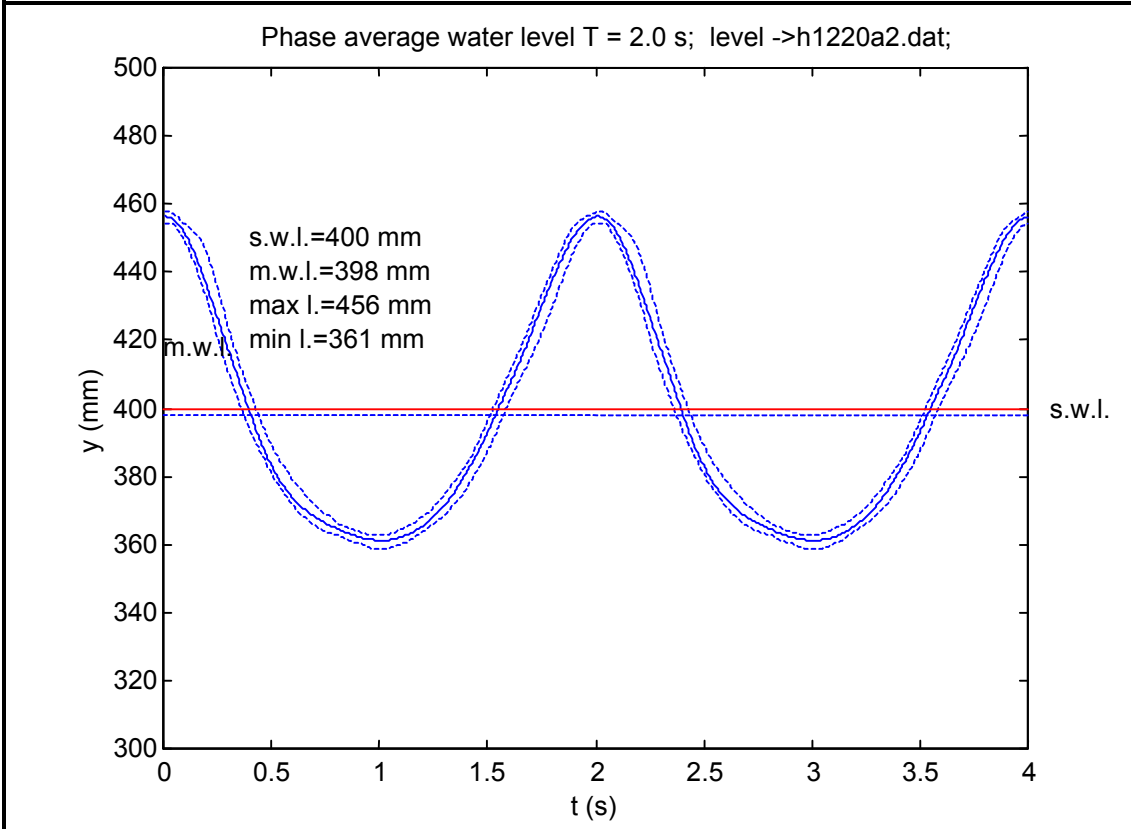
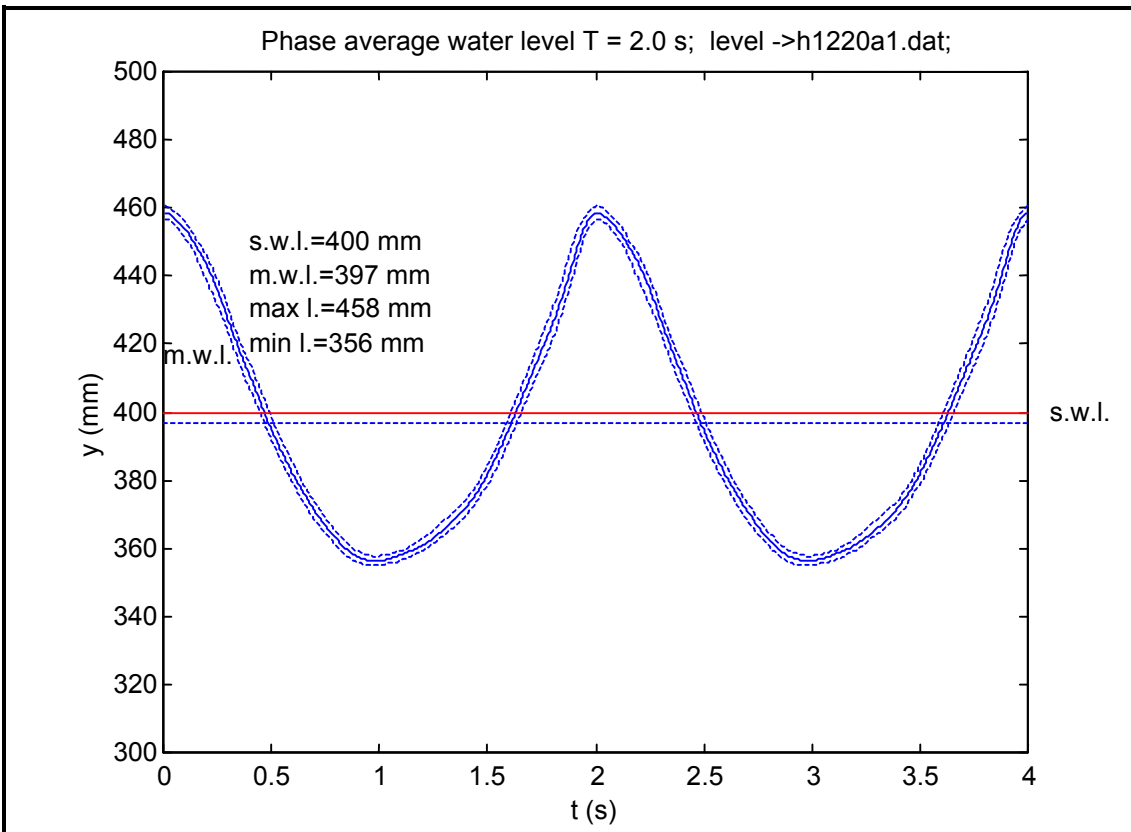

Average water level. Section 1 and 2. T=2.0 s

Series I-
T=2.0 s

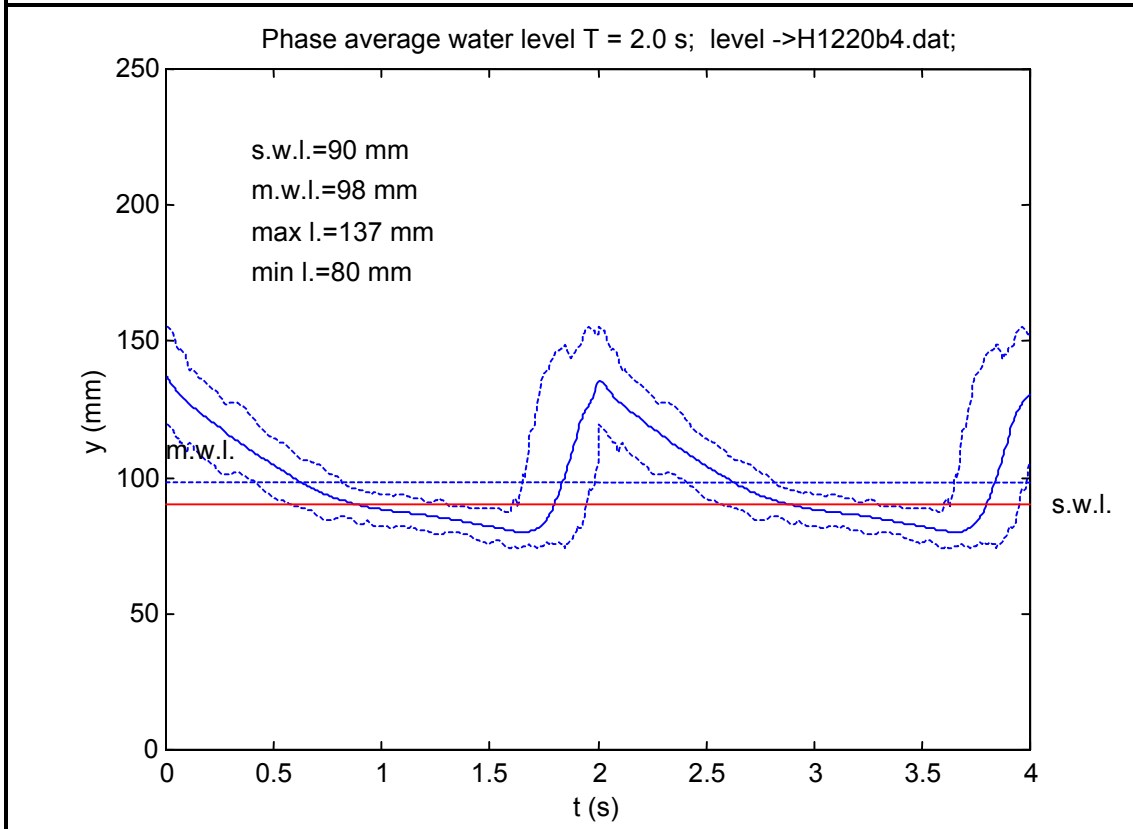
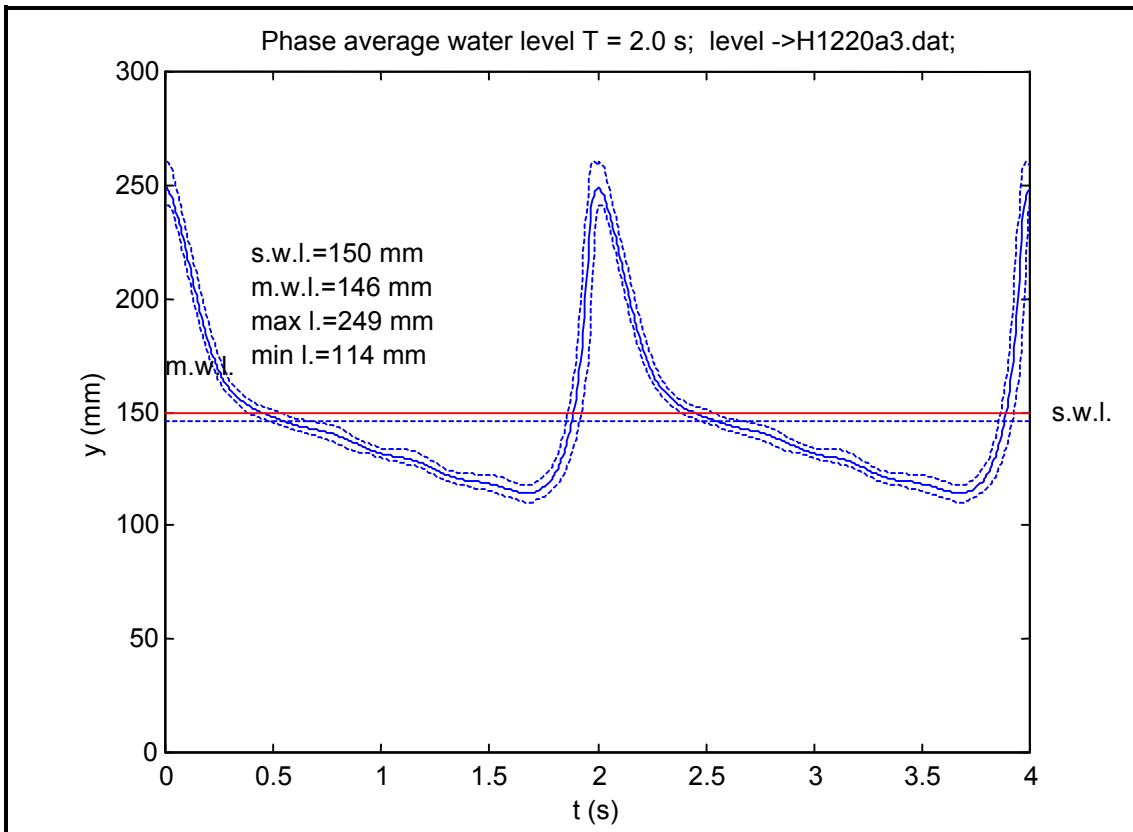

Average water level. Section 3 (A) and 4 (B). T=2.0 s

Series I-
T=2.0 s

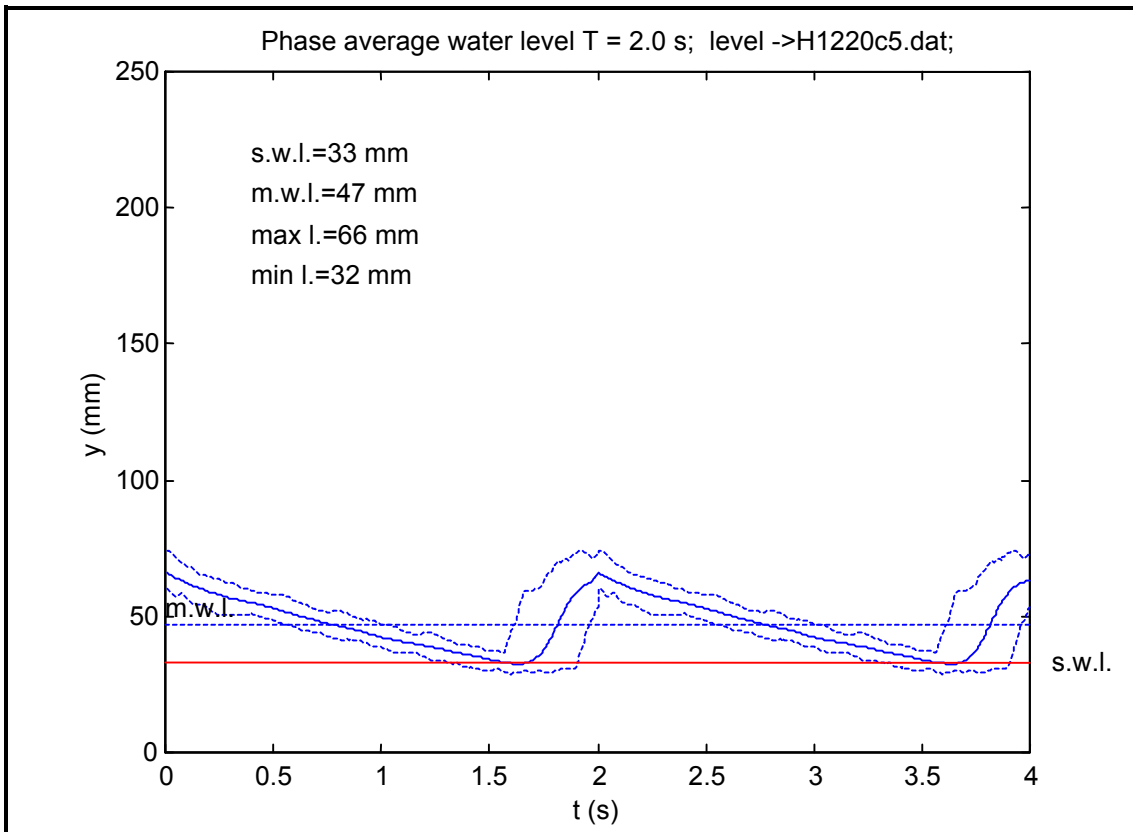

Intentionally blank

Average water level. Section 5 (C). T=2.0 s

Series I-
T=2.0 s

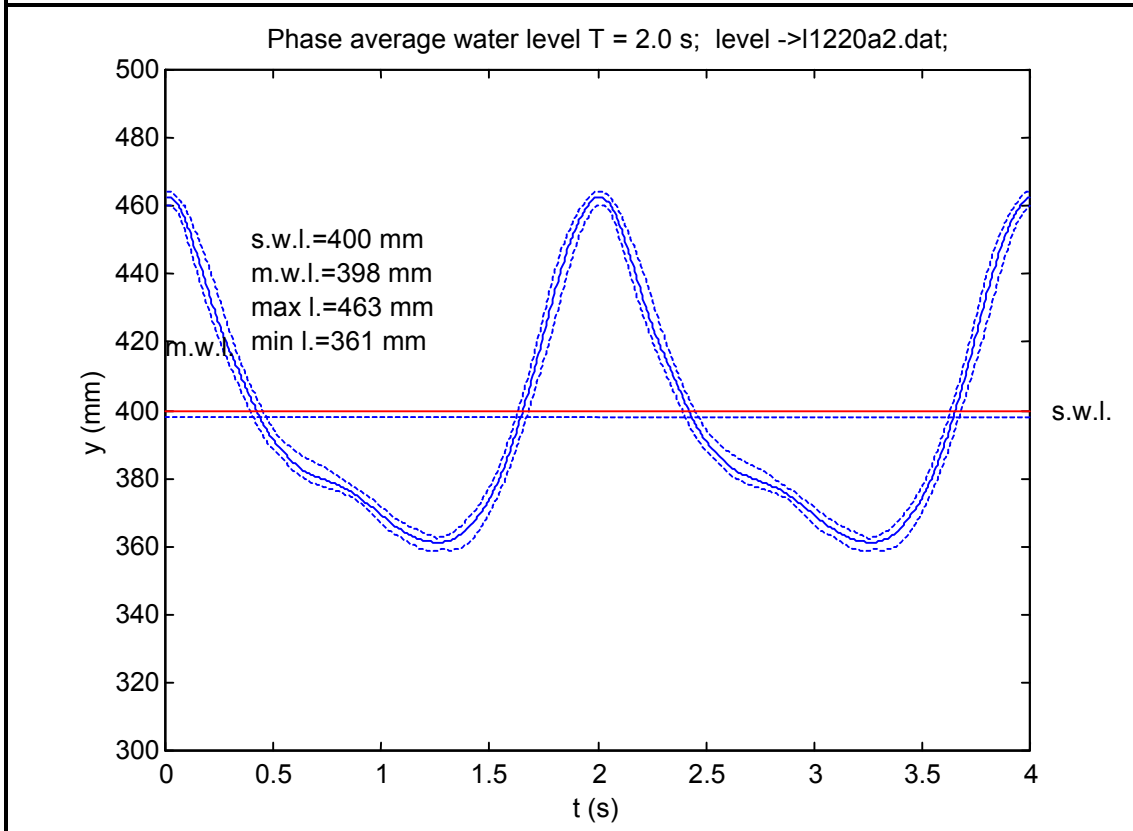
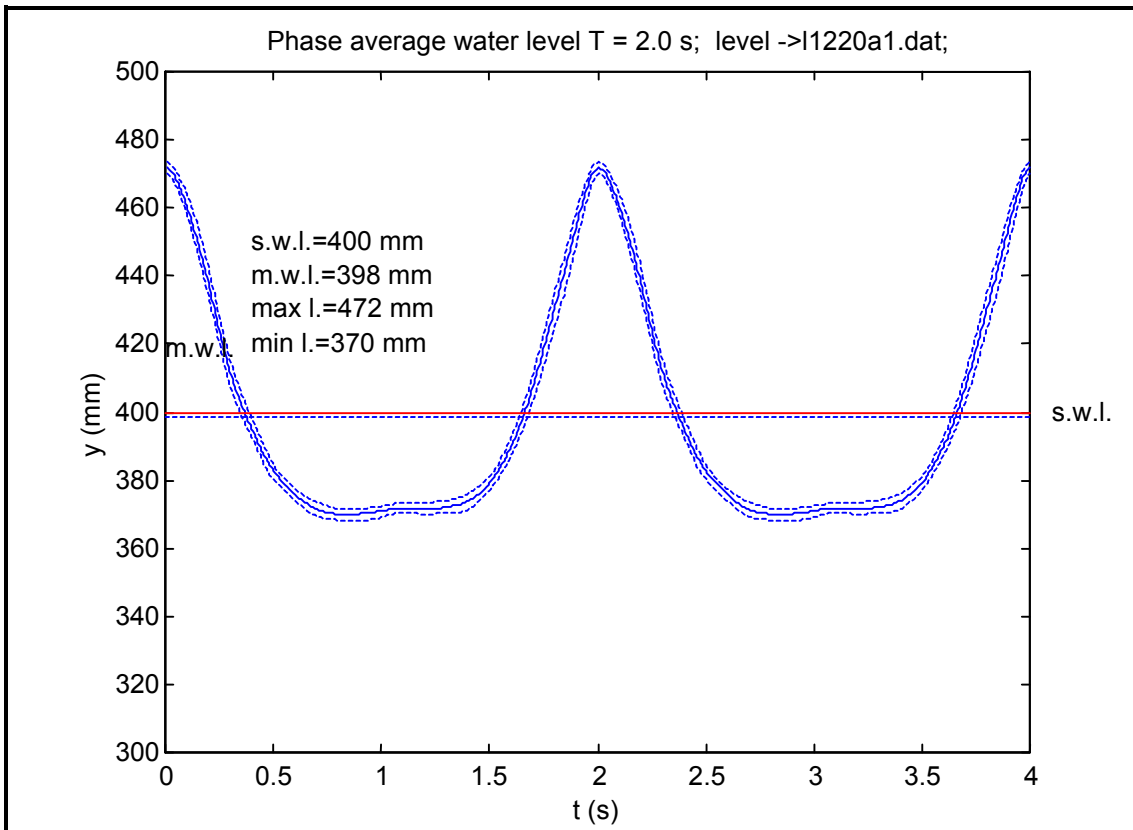

Average water level. Section 1 and 2. T=2.0 s

Series II-
T=2.0 s

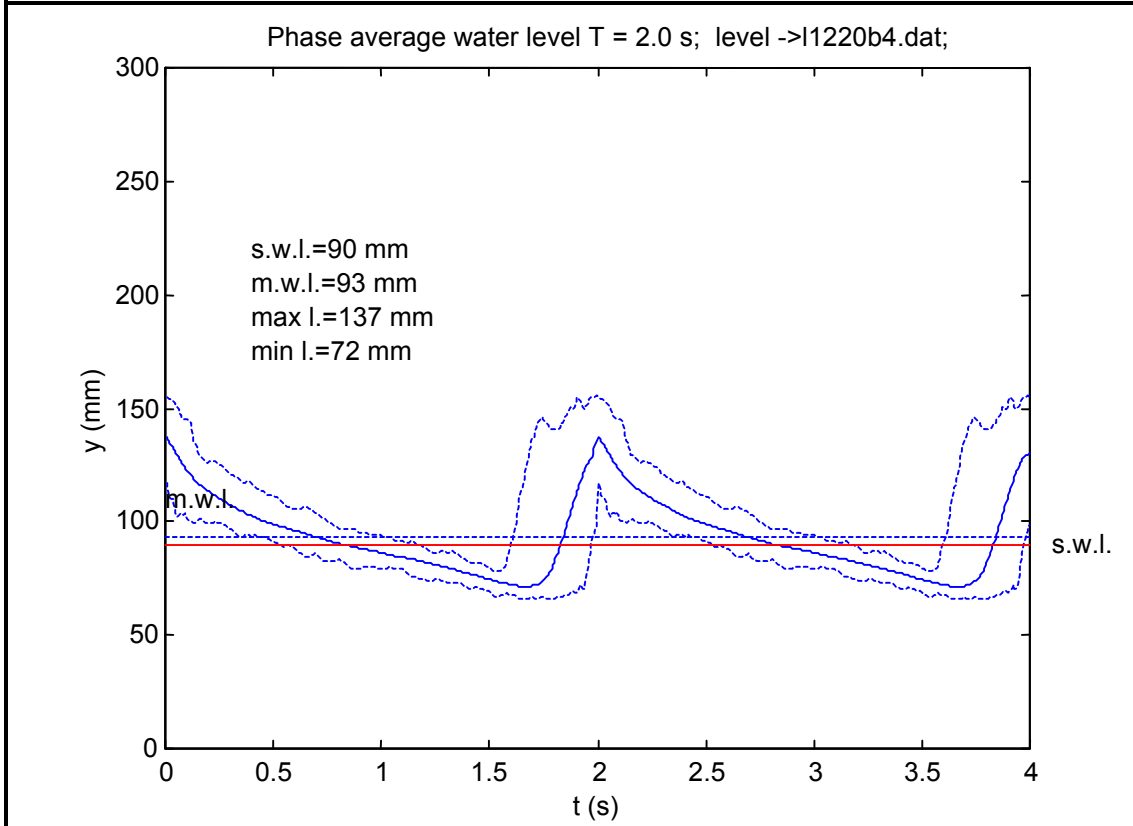
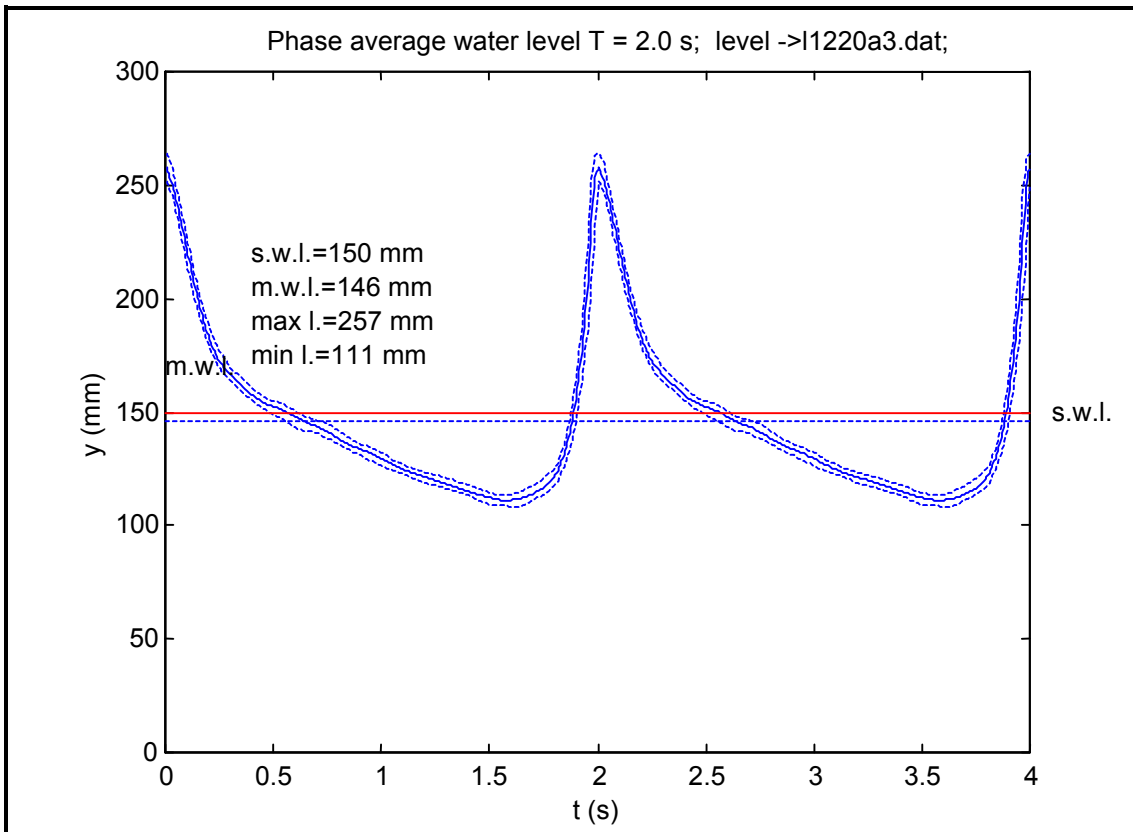

Average water level. Section 3 (A) and 4 (B). T=2.0 s

Series II-
T=2.0 s

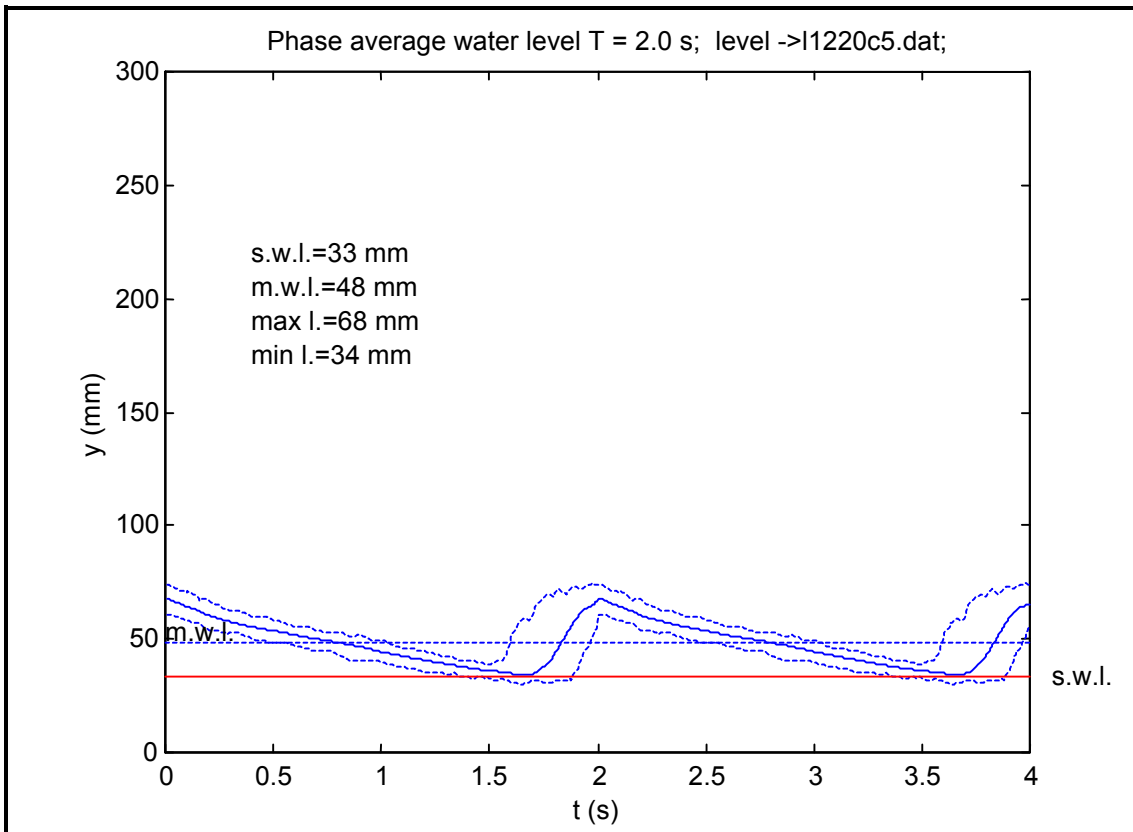

Intentionally blank

Average water level. Section 5 (C). T=2.0 s

Series II-
T=2.0 s

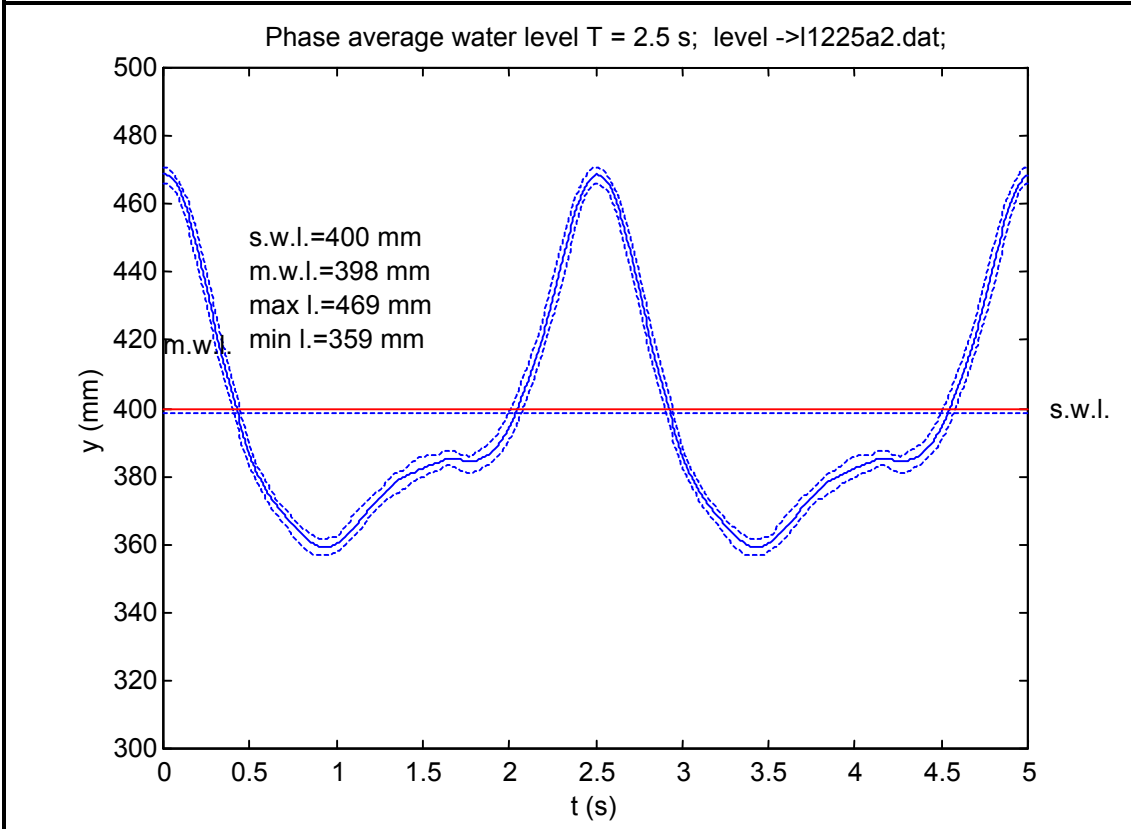
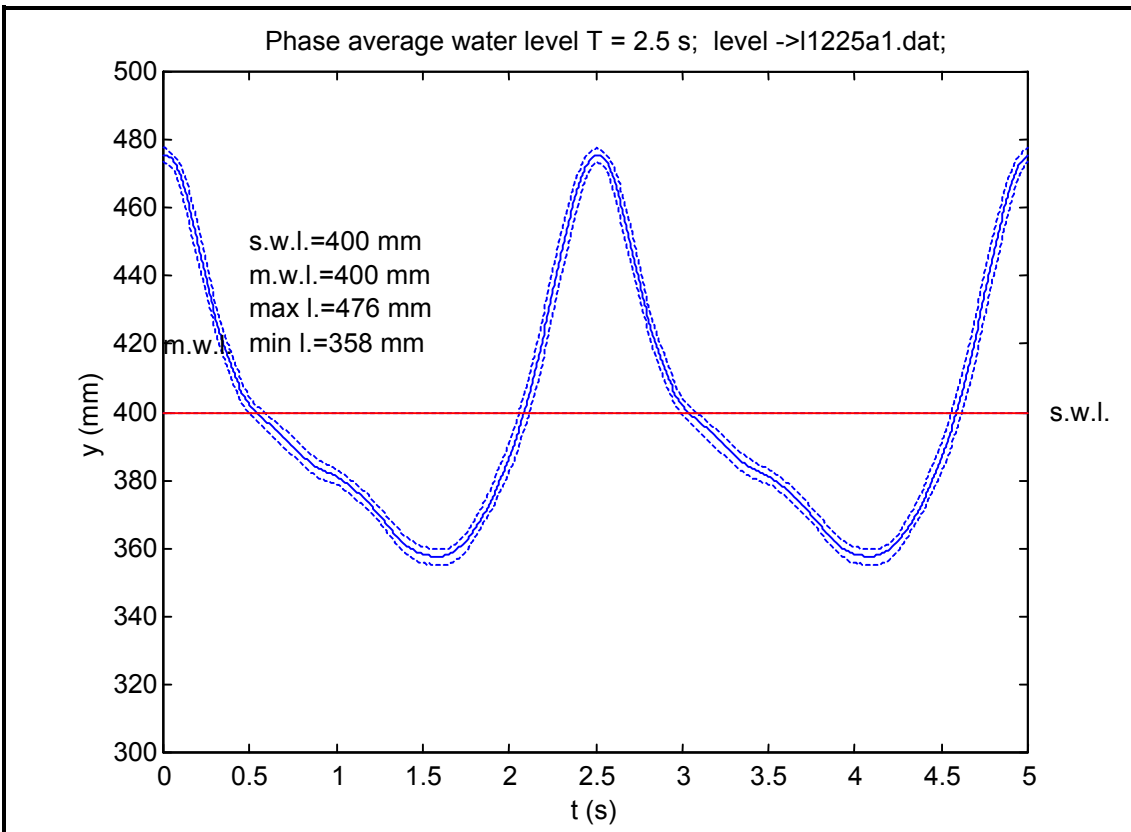

Average water level. Section 1 and 2. T=2.5 s

Series II-
T=2.5 s

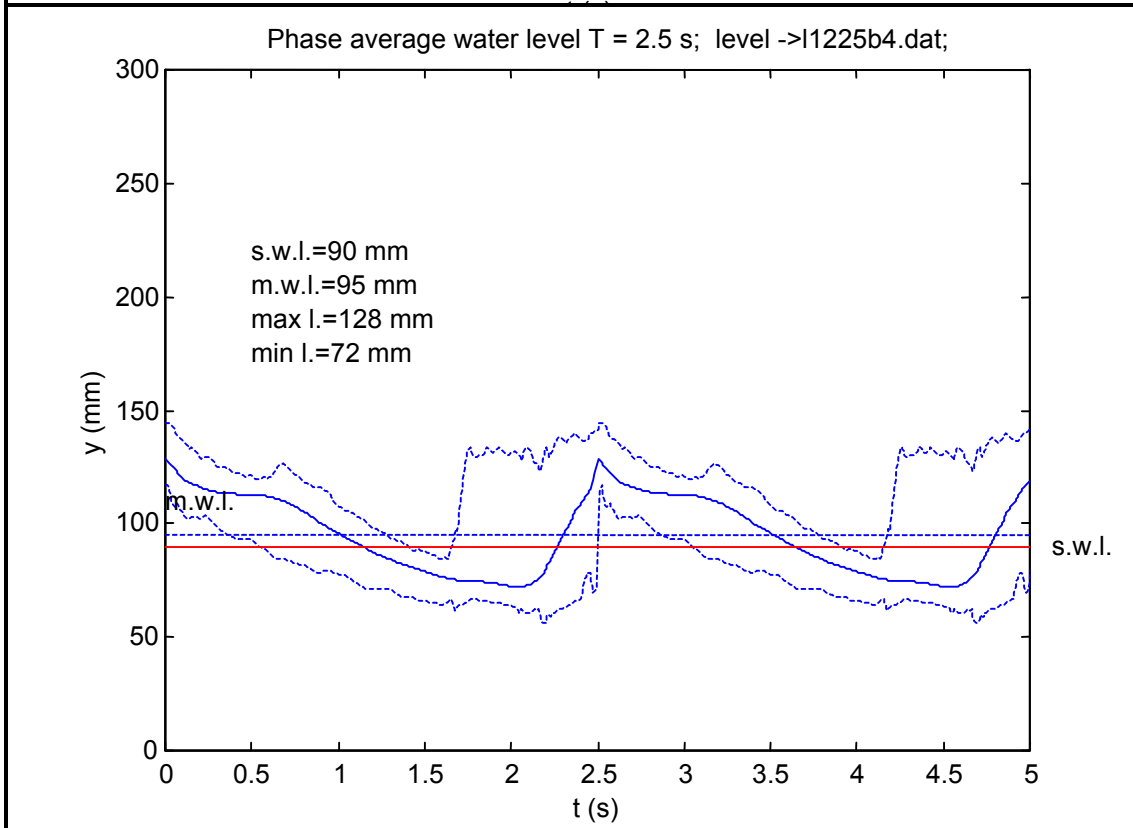
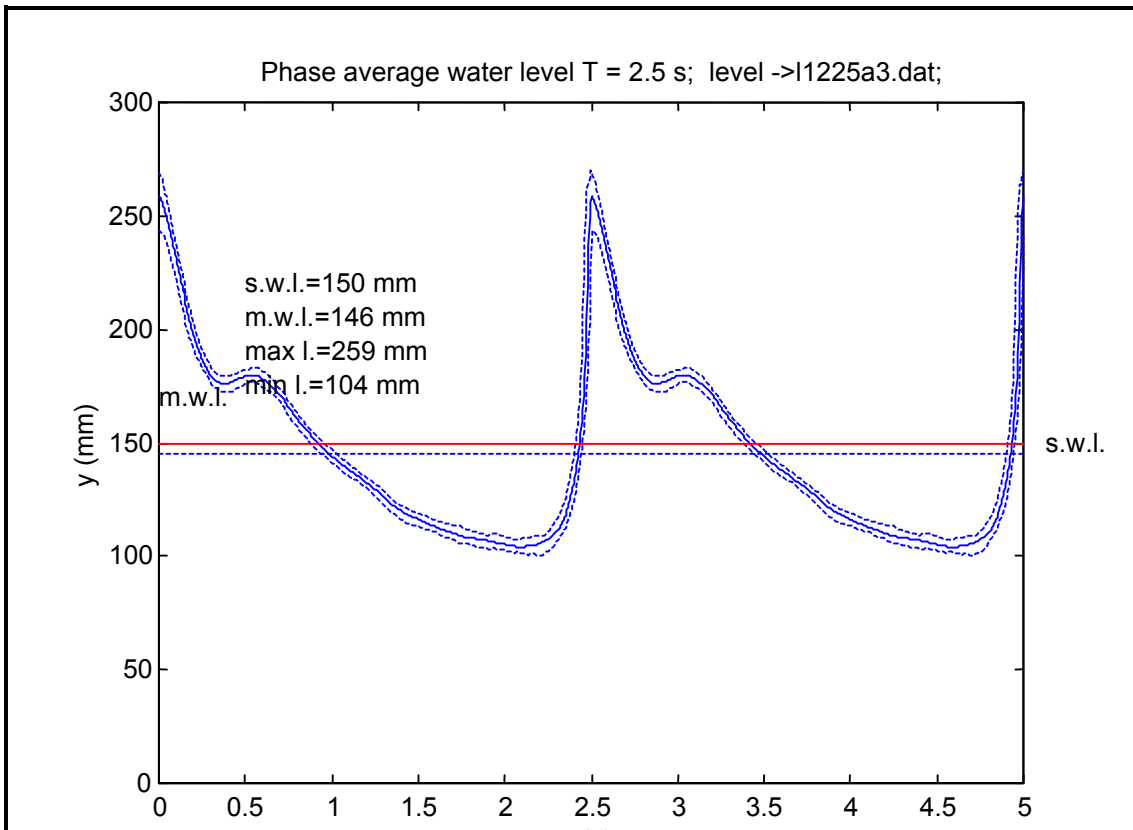

Average water level. Section 3 (A) and 4 (B). T=2.5 s

Series II-
T=2.5 s

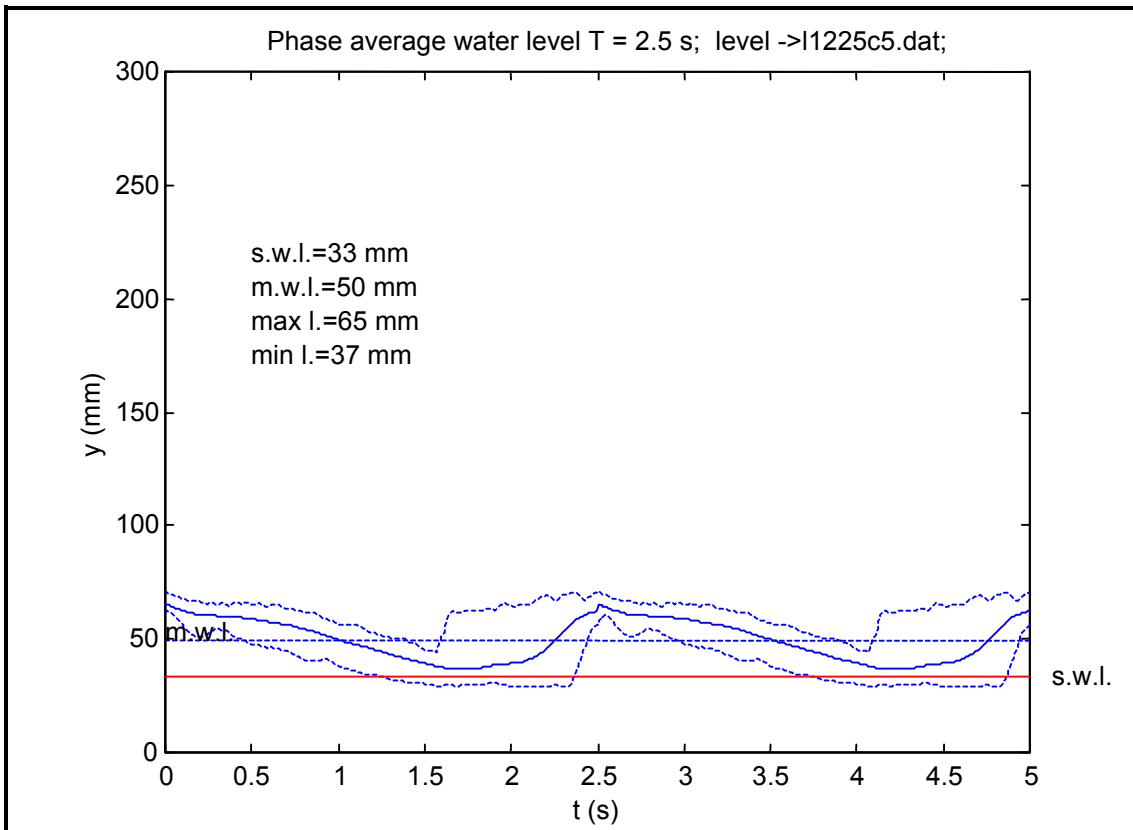

Intentionally blank

Average water level. Section 5 (C). T=2.5 s

Series II-
T=2.5 s

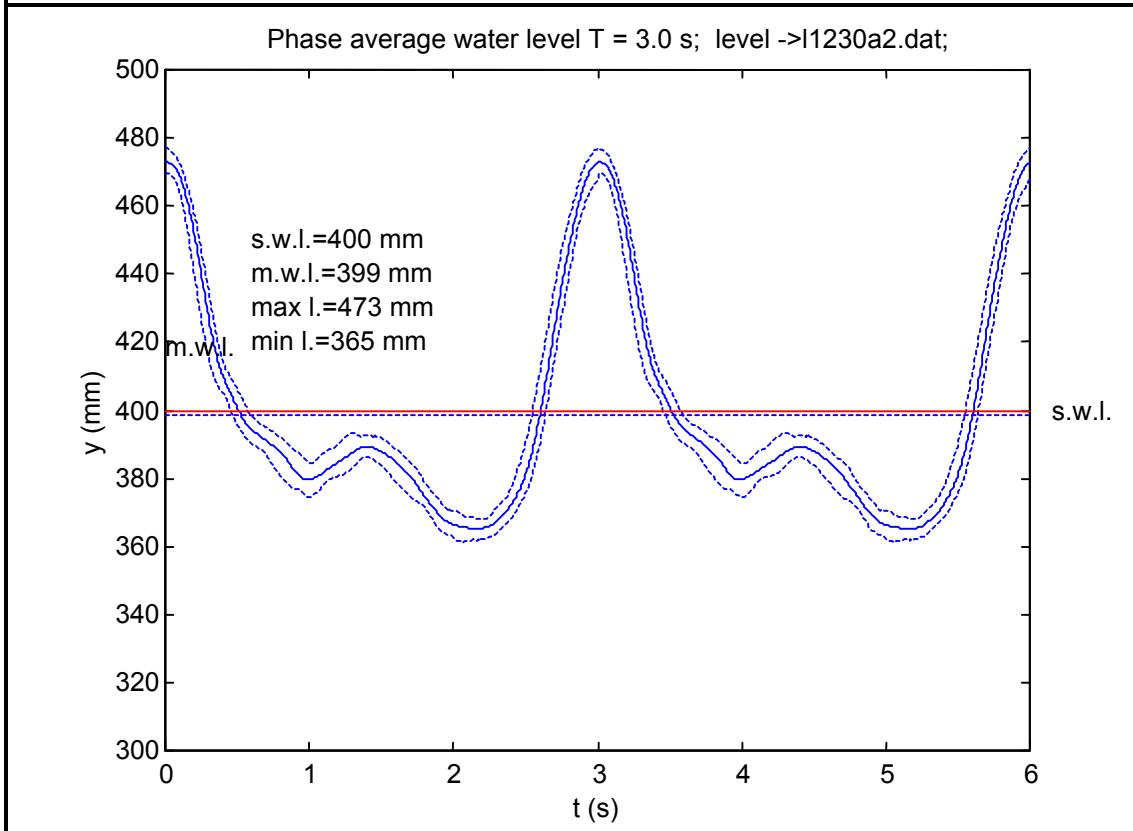
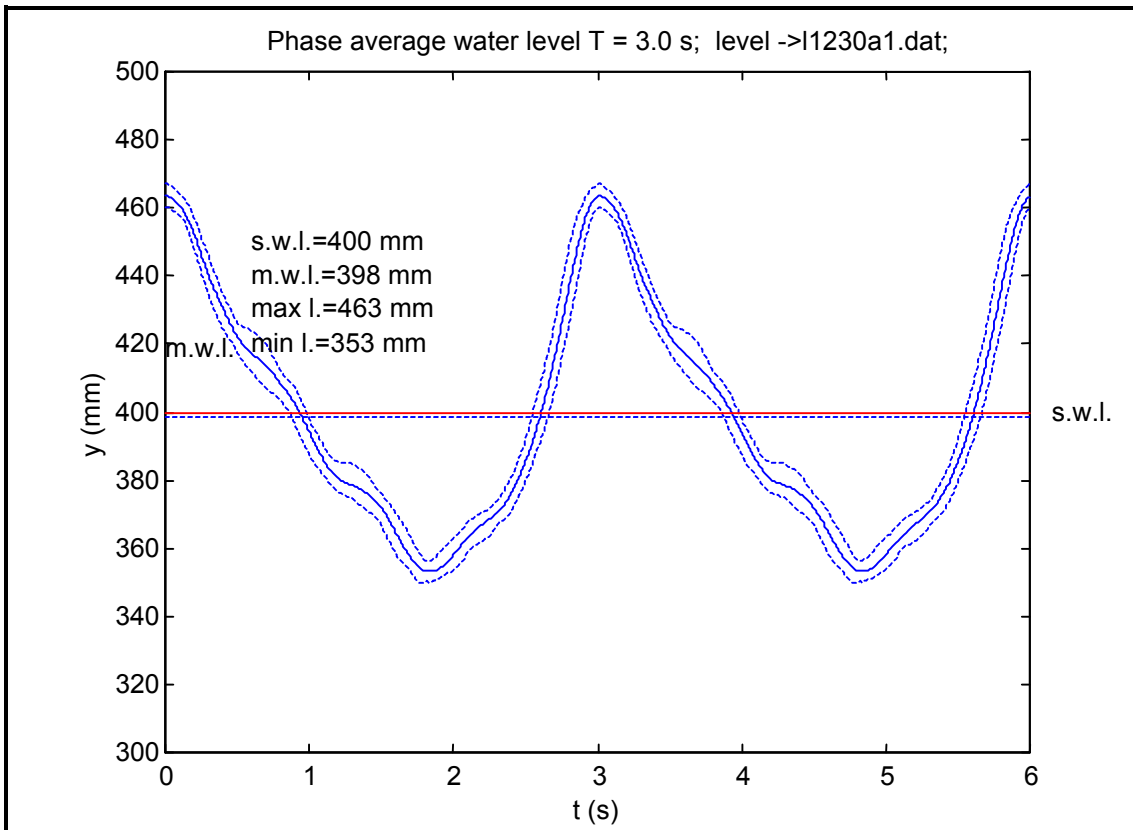

Average water level. Section 1 and 2. T=3.0 s

Series II-
T=3.0 s

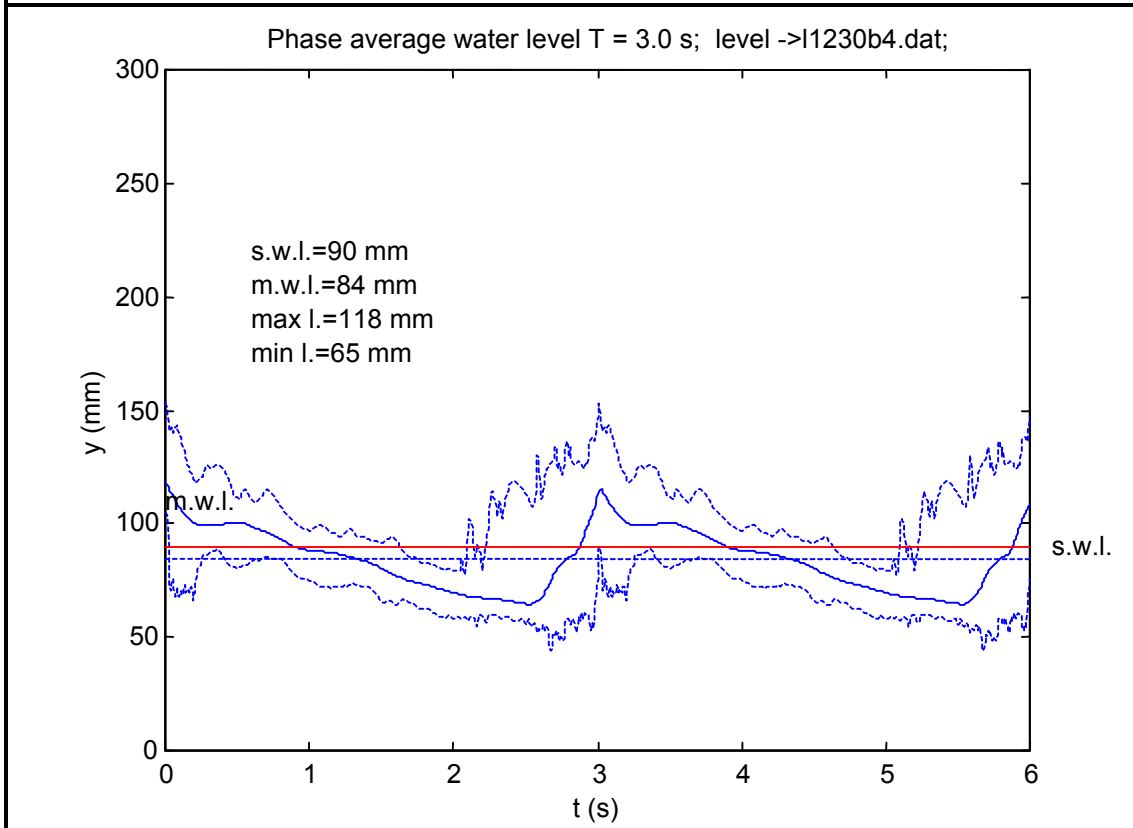
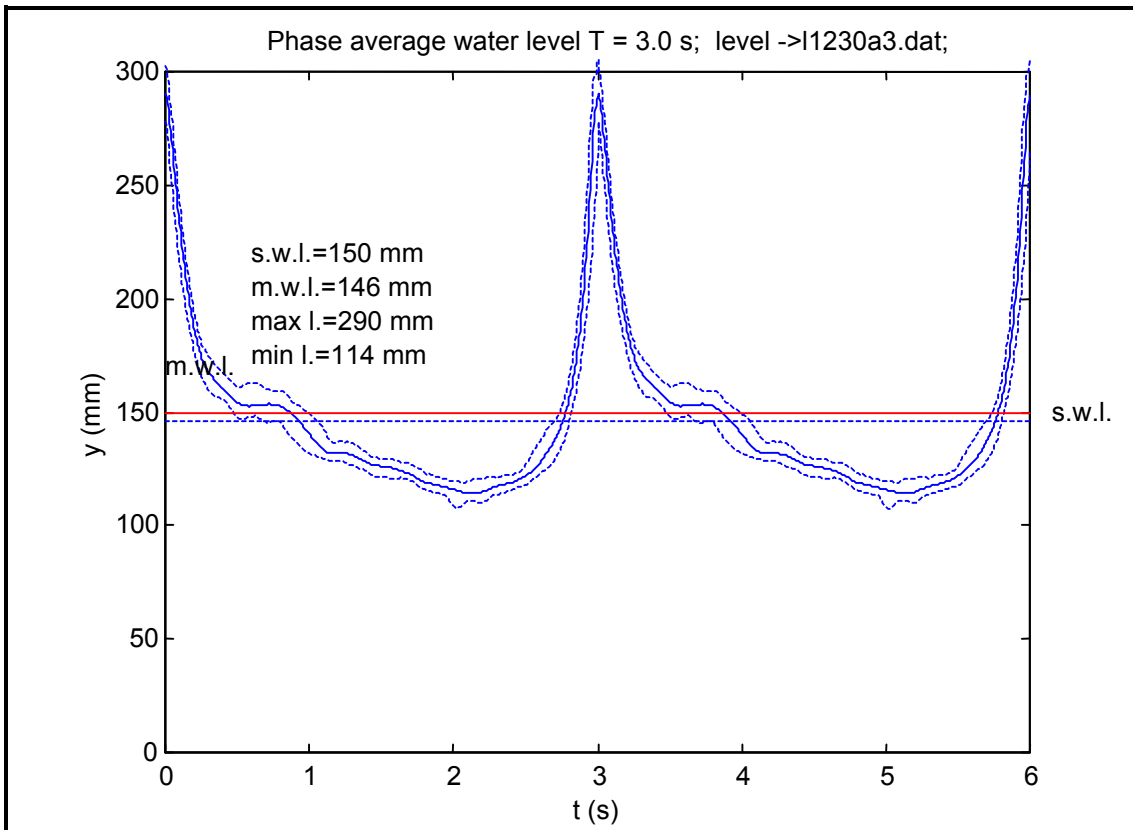

Average water level. Section 3 (A) and 4 (B). T=3.0 s

Series II-
T=3.0 s

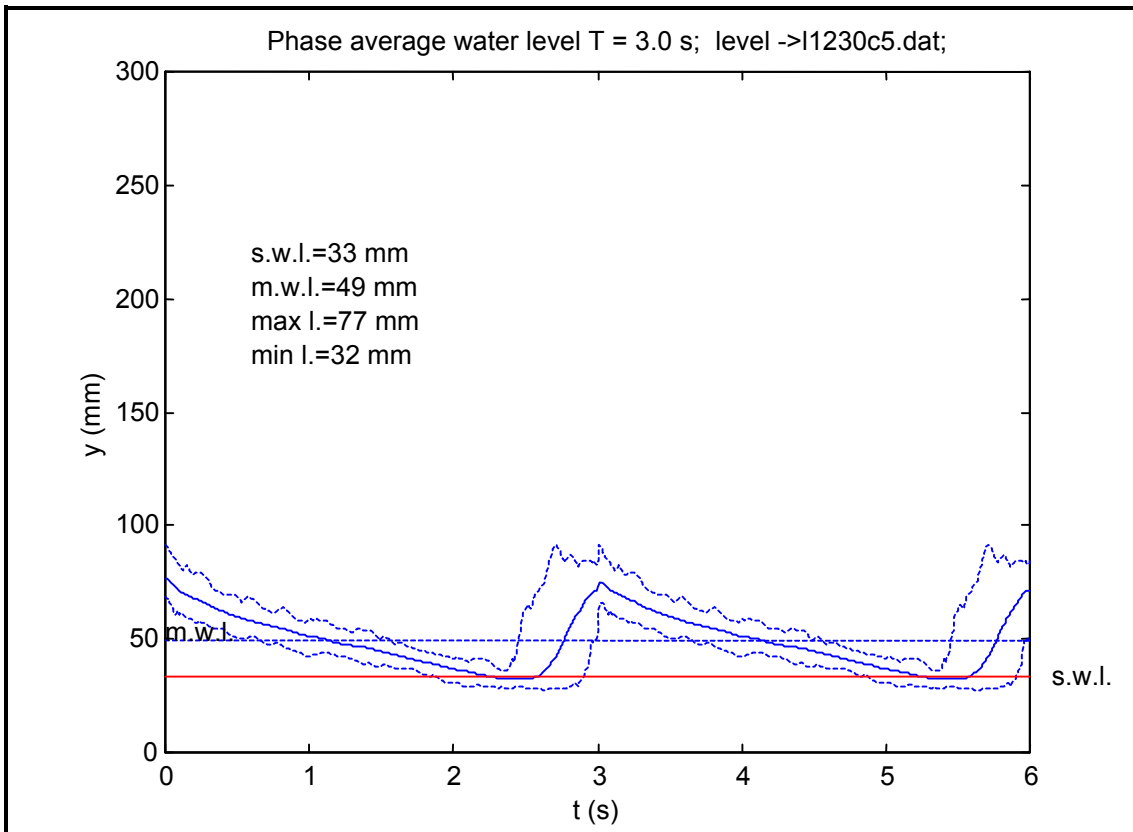

Intentionally blank

Average water level. Section 5 (C). T=3.0 s

Series II-
T=3.0 s

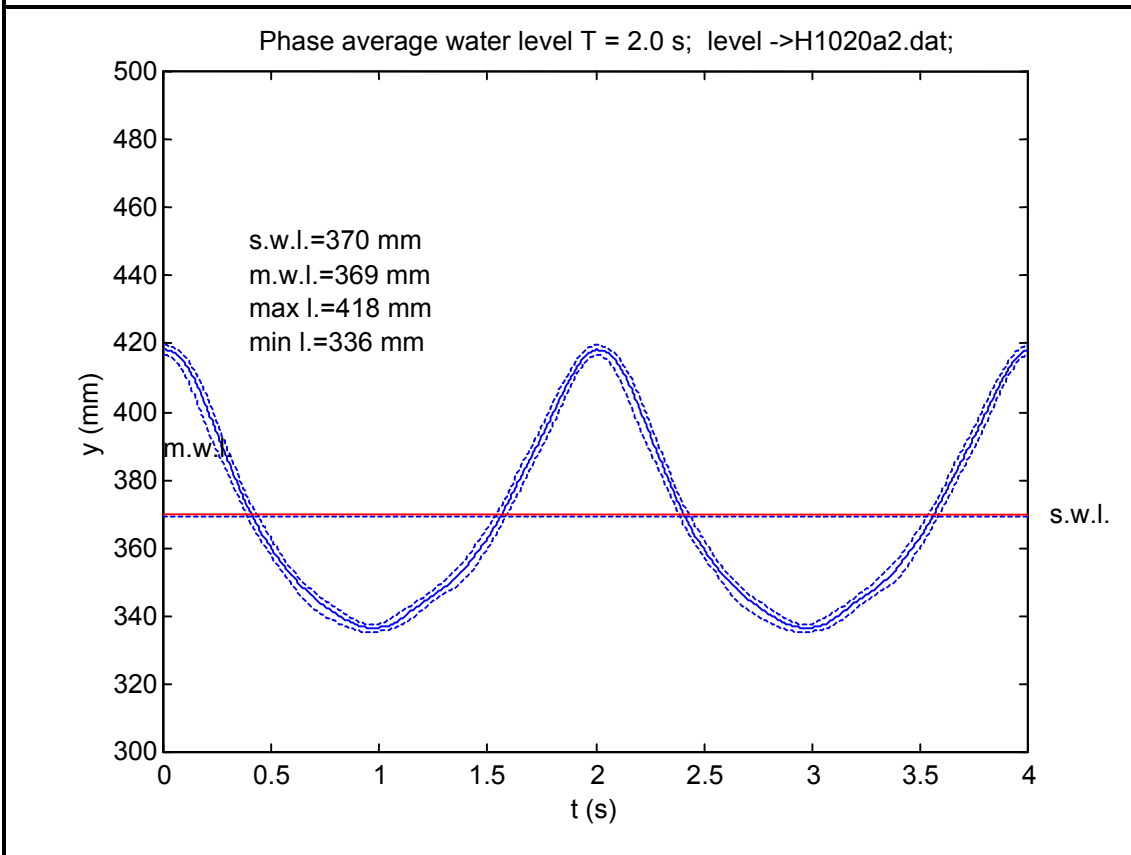
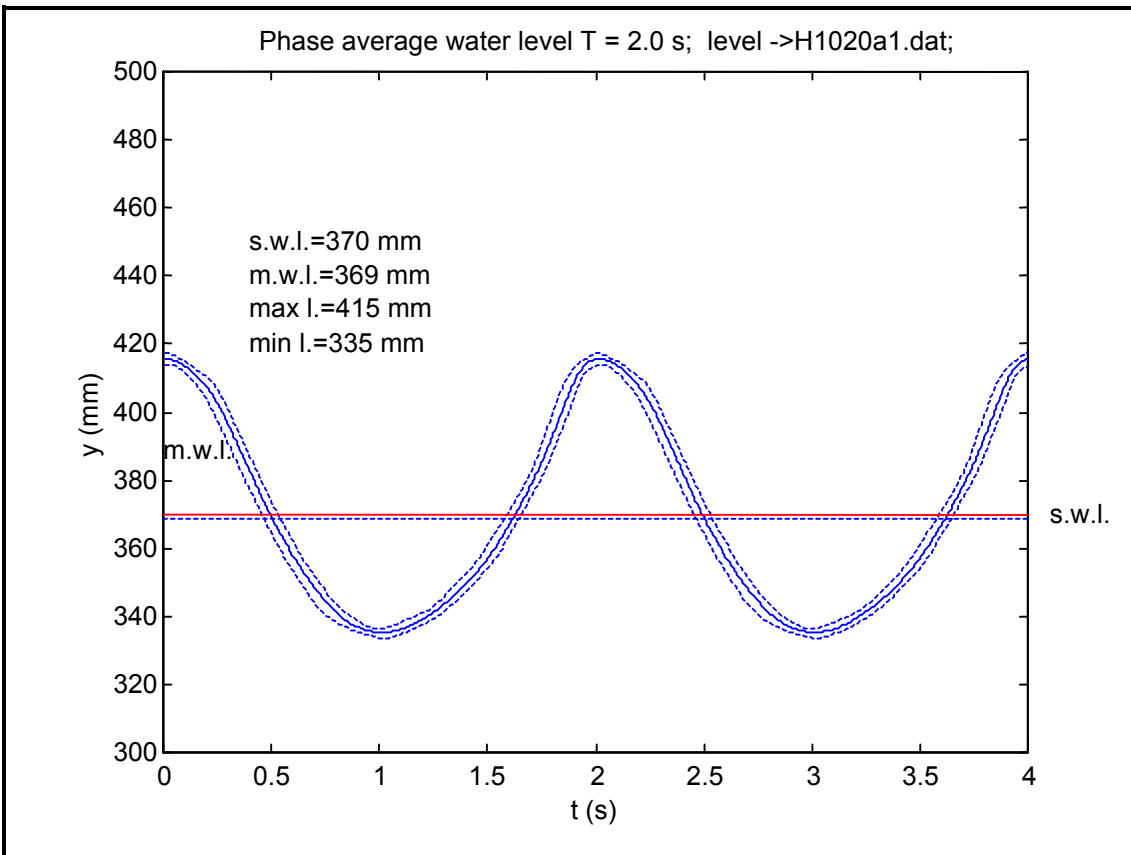

Average water level. Section 1 and 2. T=2.0 s

Series III-
T=2.0 s

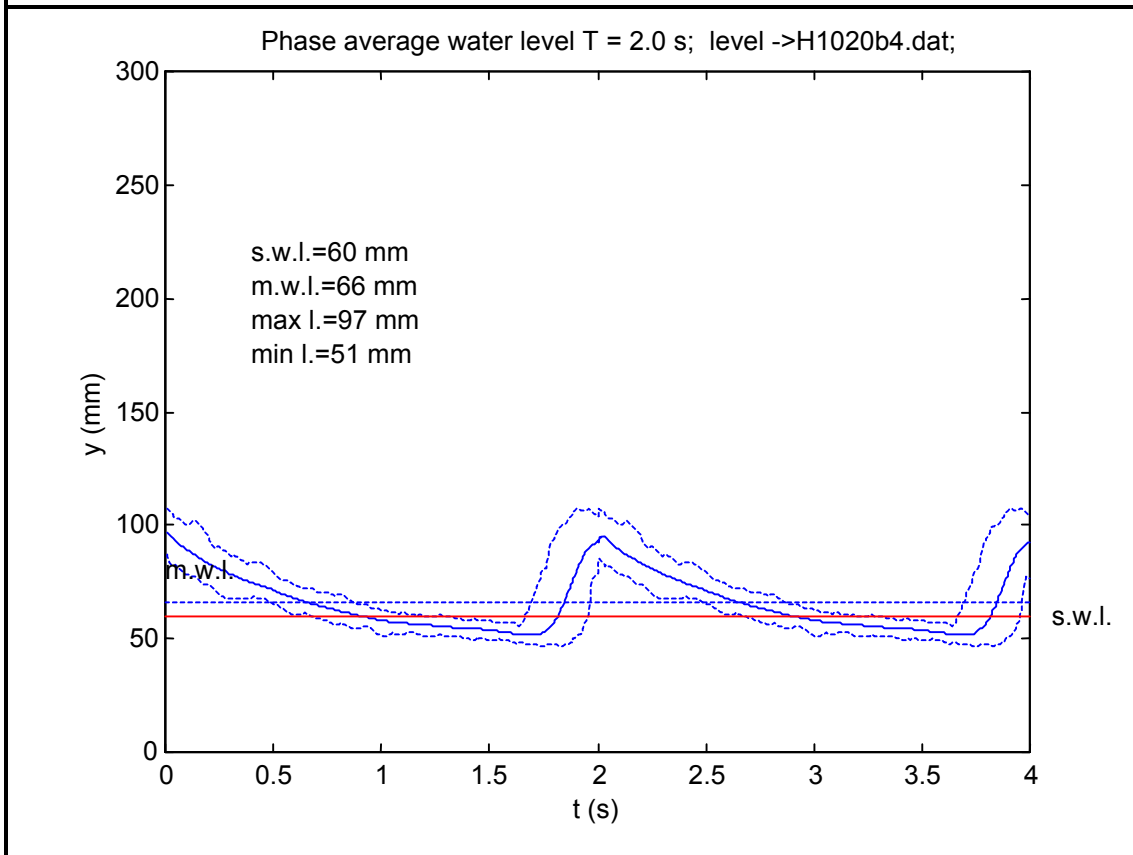
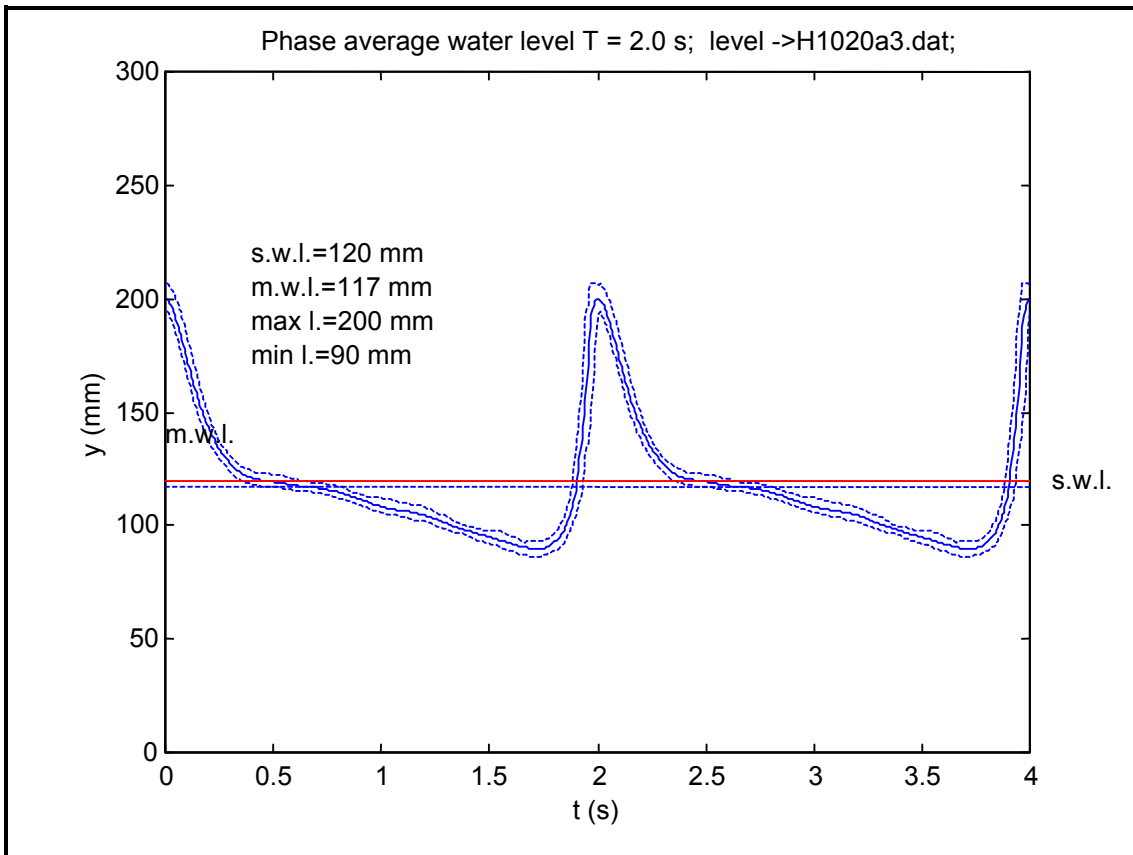

Average water level. Section 3 (A) and 4 (B). T=2.0 s

**Series III-
T=2.0 s**

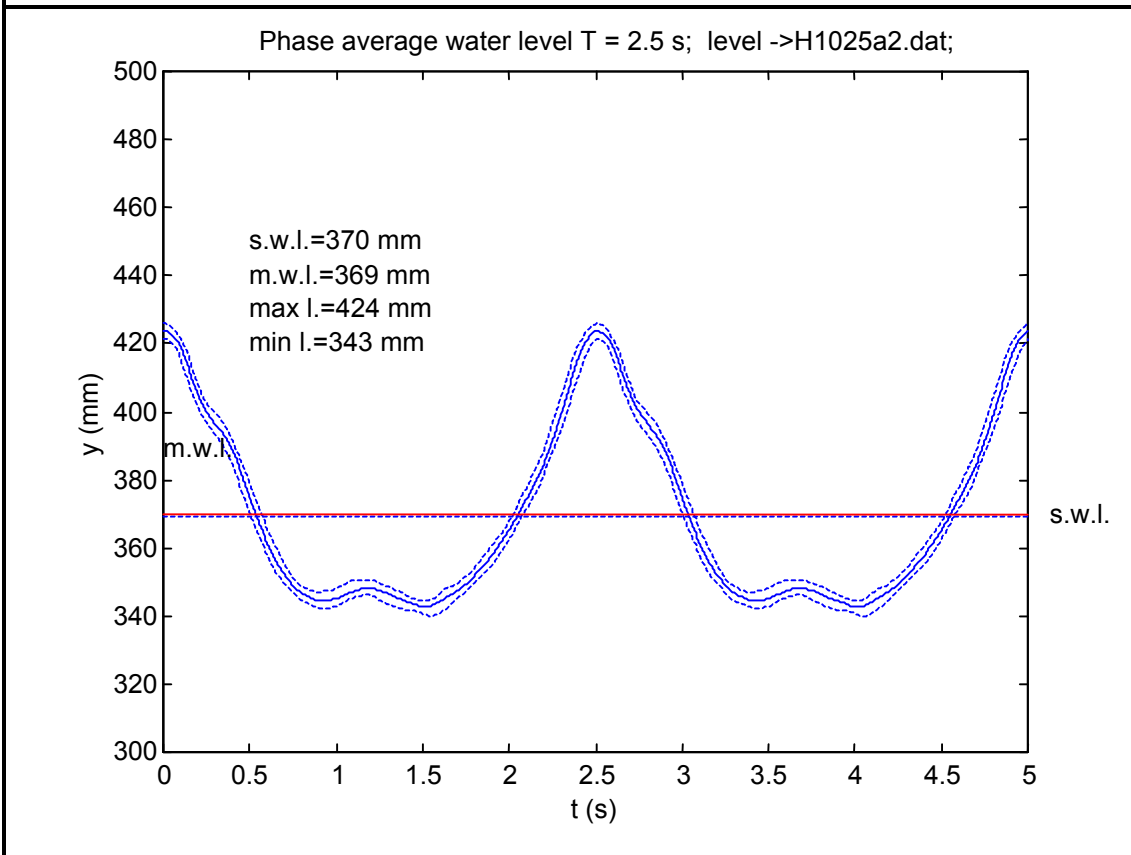
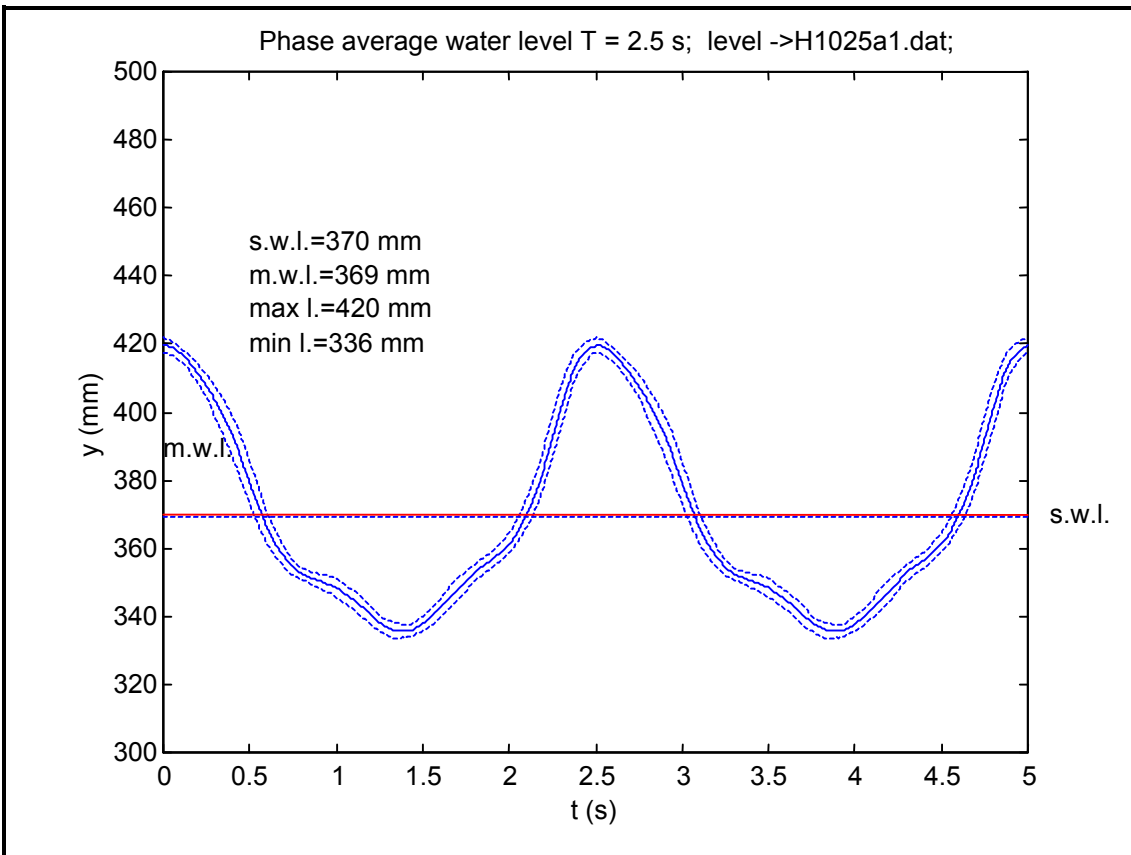

Average water level. Section 1 and 2. T=2.5 s

Series III-
T=2.5 s

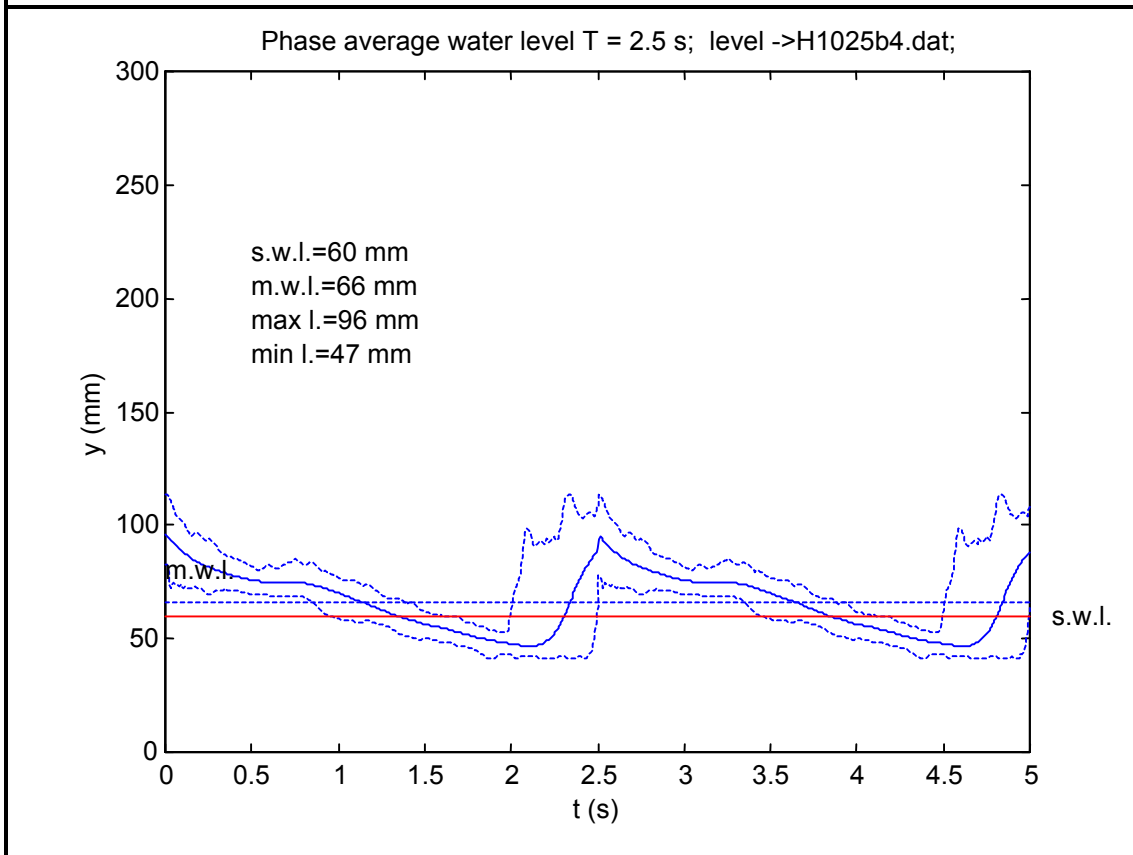
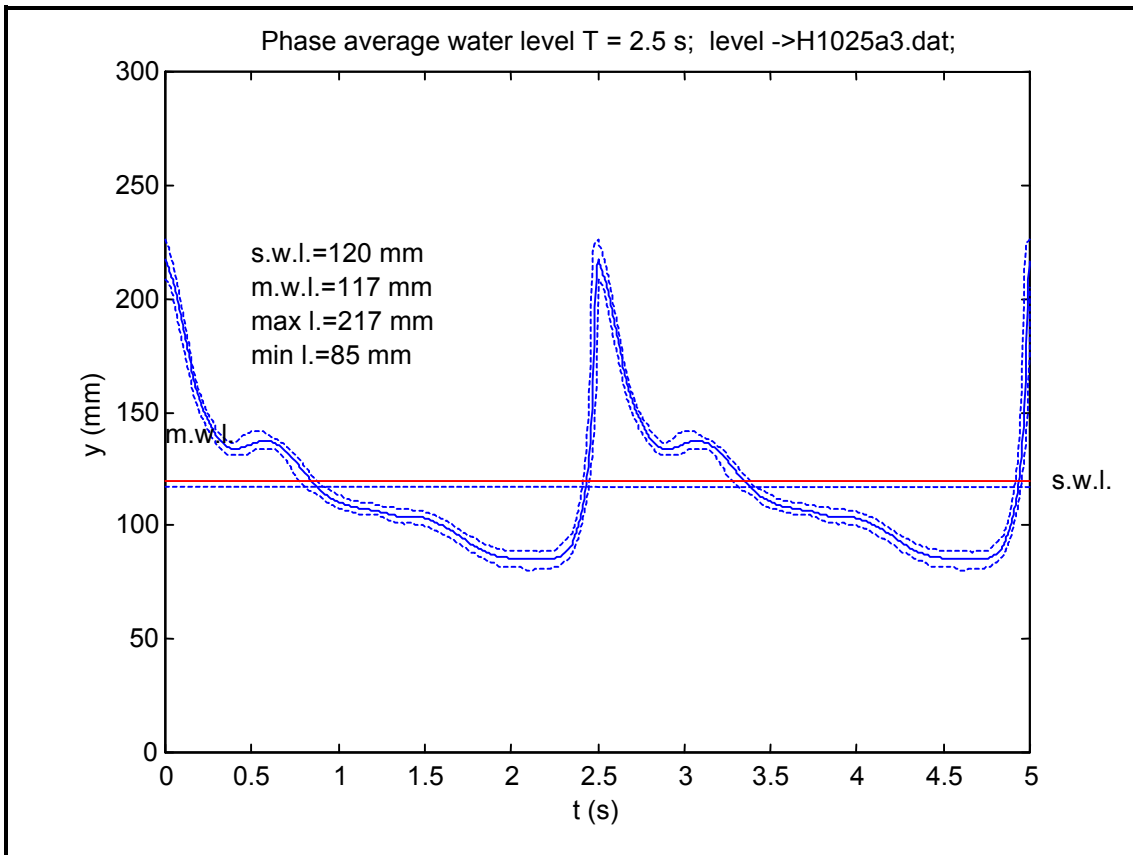

Average water level. Section 3 (A) and 4 (B). T=2.5 s	Series III- T=2.5 s
---	--------------------------------

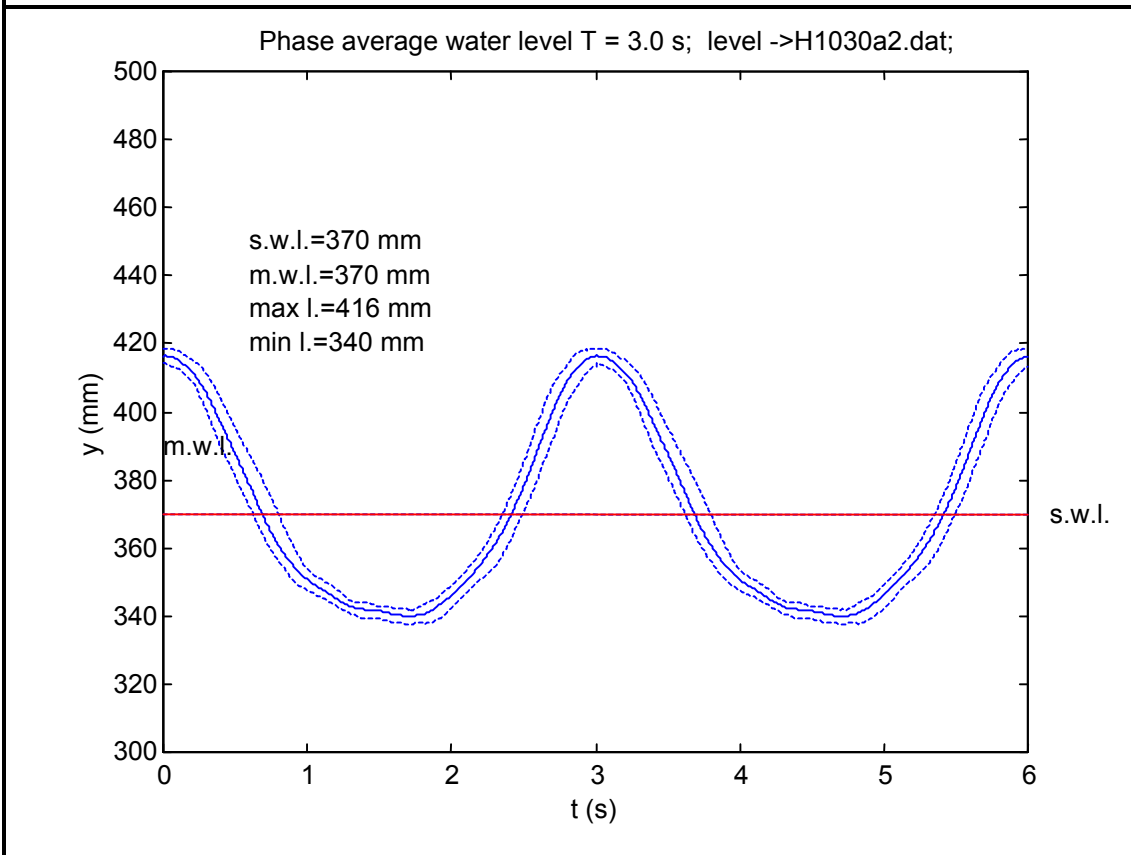
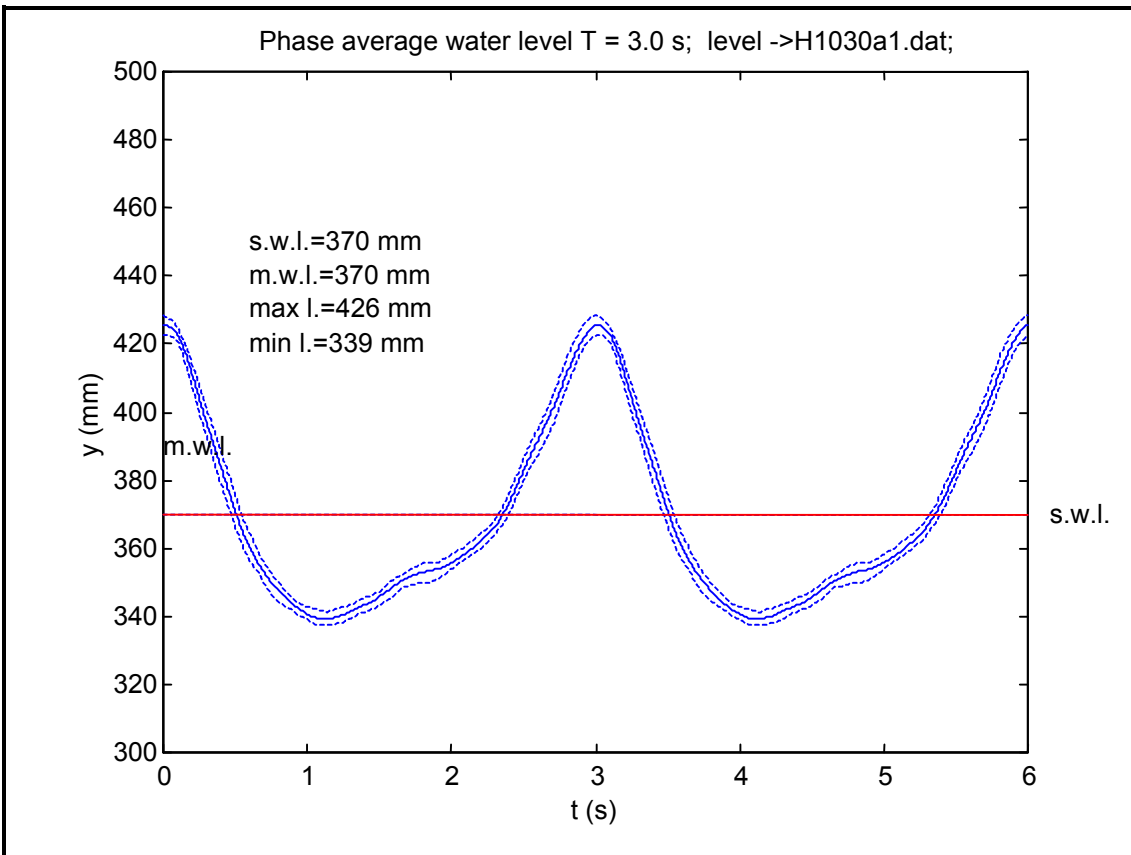

Average water level. Section 1 and 2. T=3.0 s

Series III-
T=3.0 s

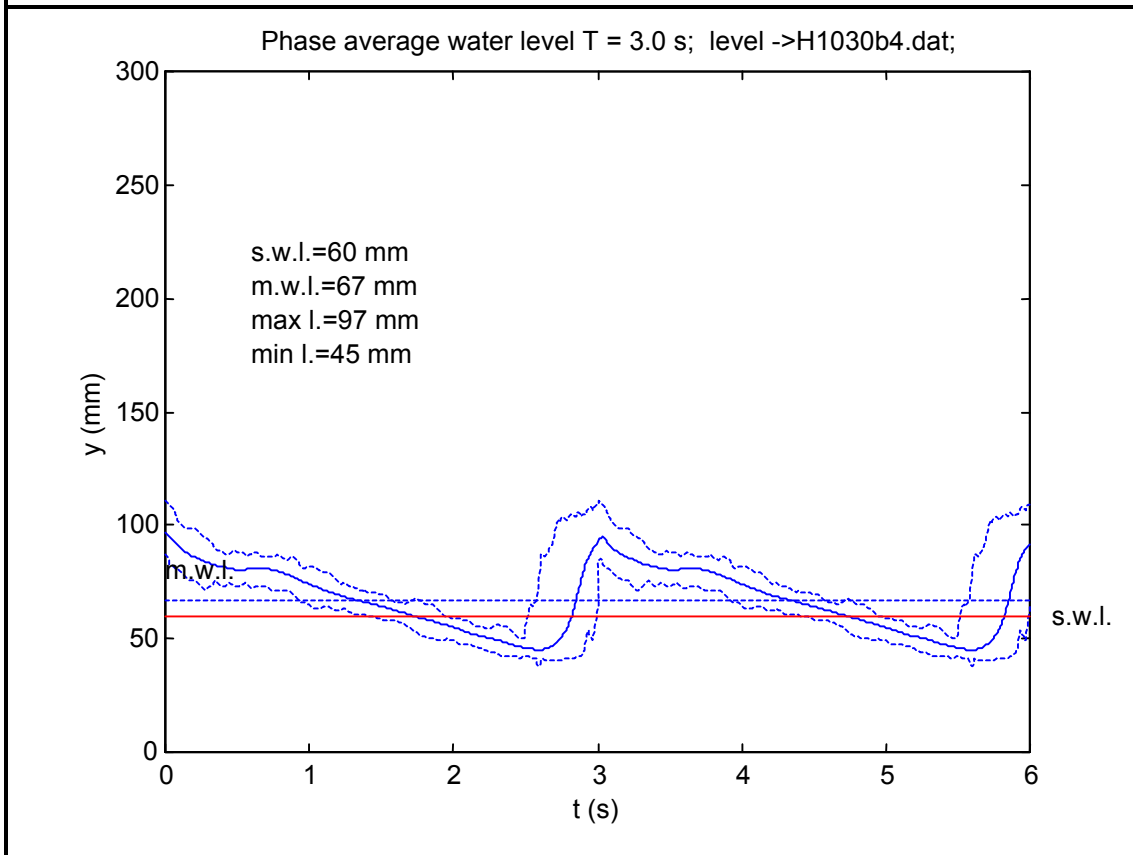
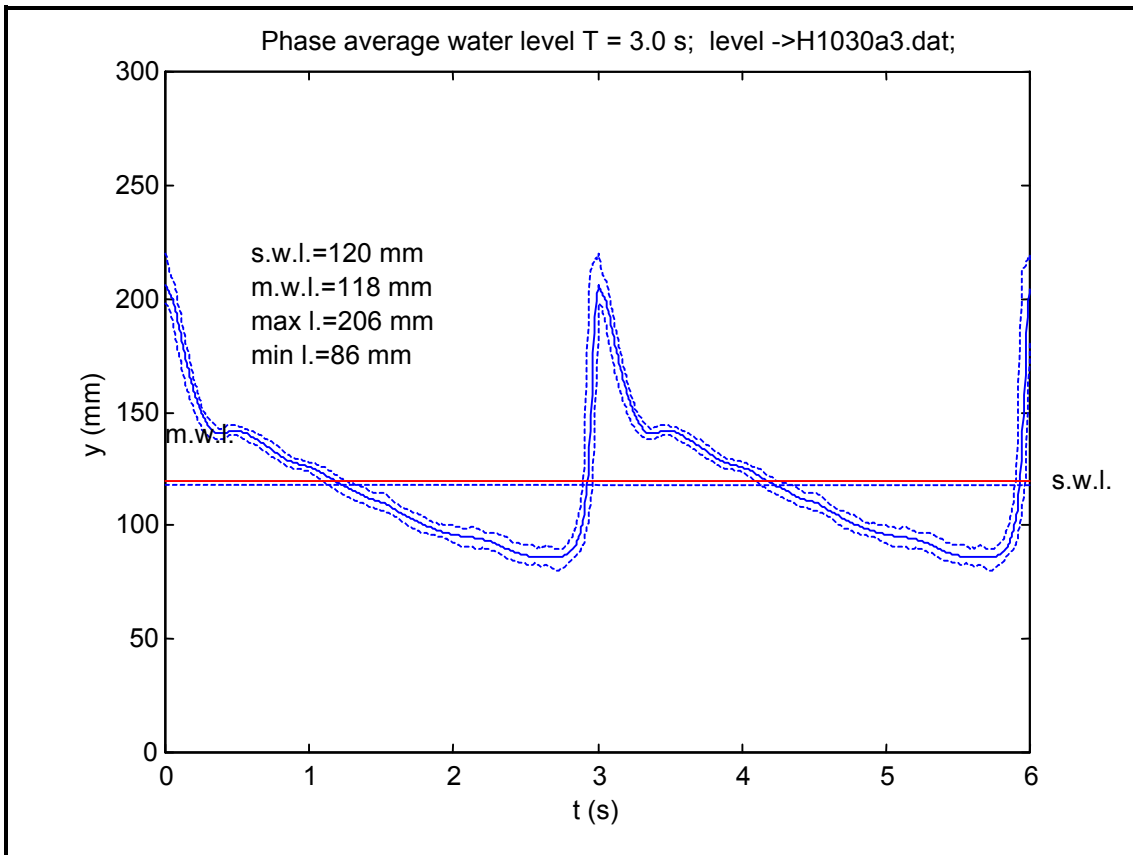

Average water level. Section 3 (A) and 4 (B). T=3.0 s

Series III-
T=3.0 s

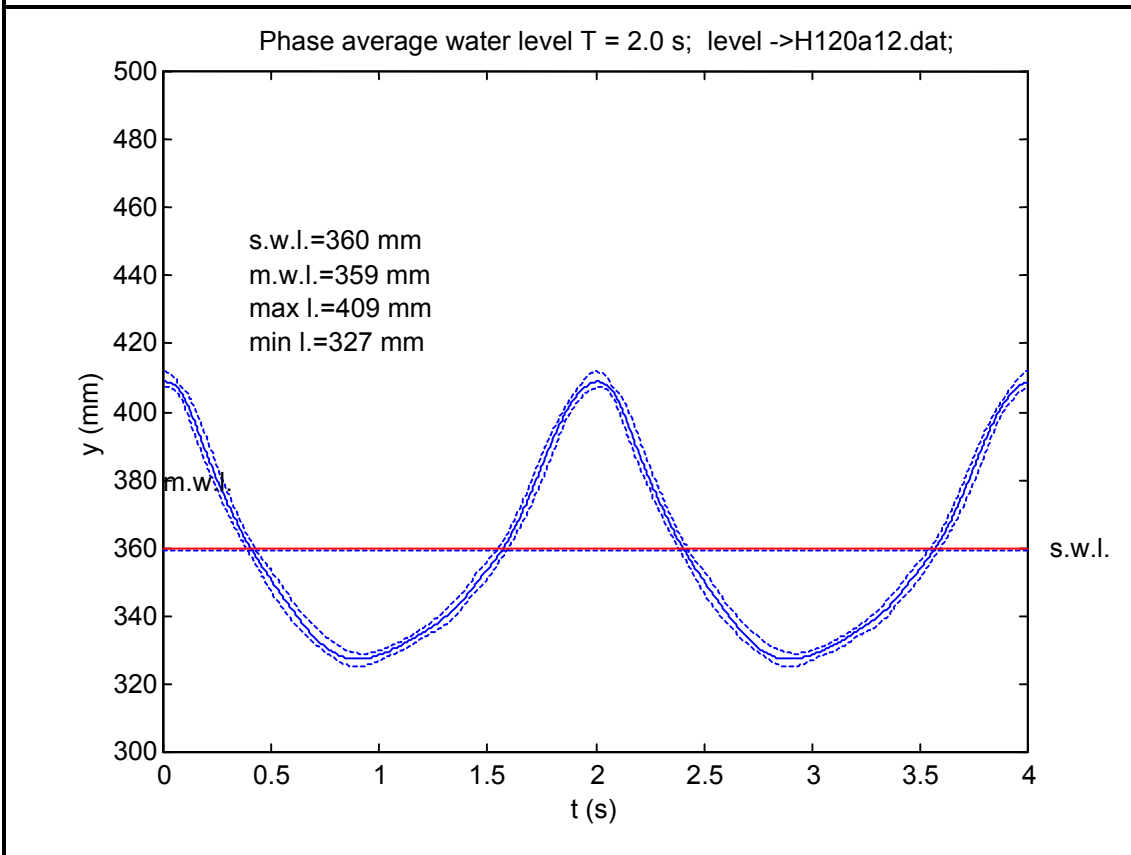
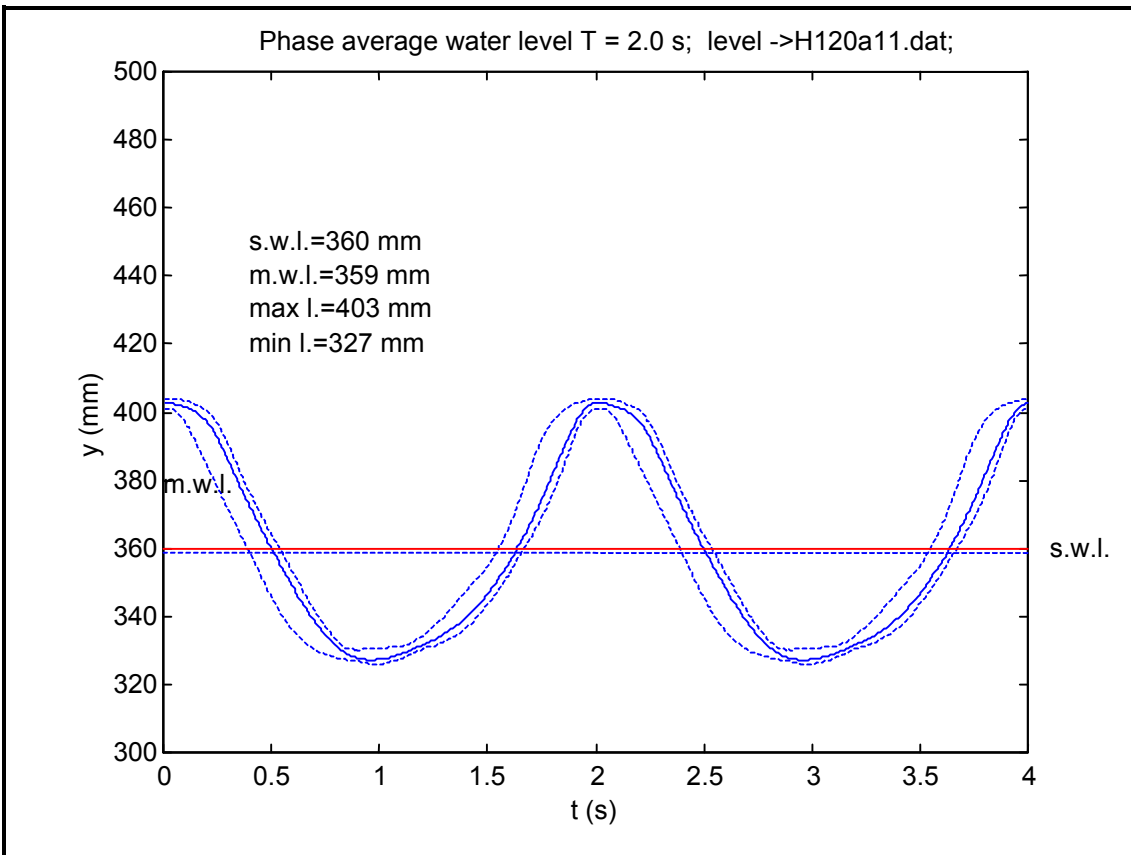

Average water level. Section 1 and 2. T=2.0 s

Series IV-
T=2.0 s

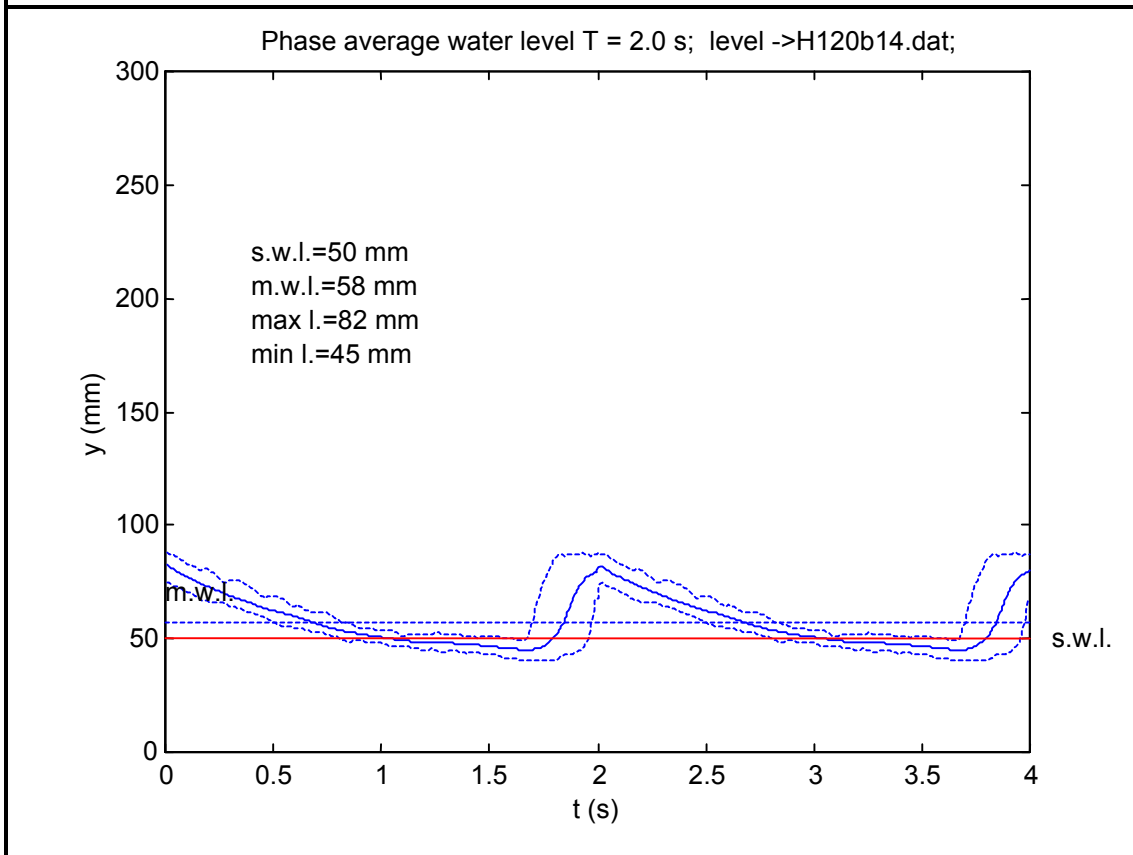
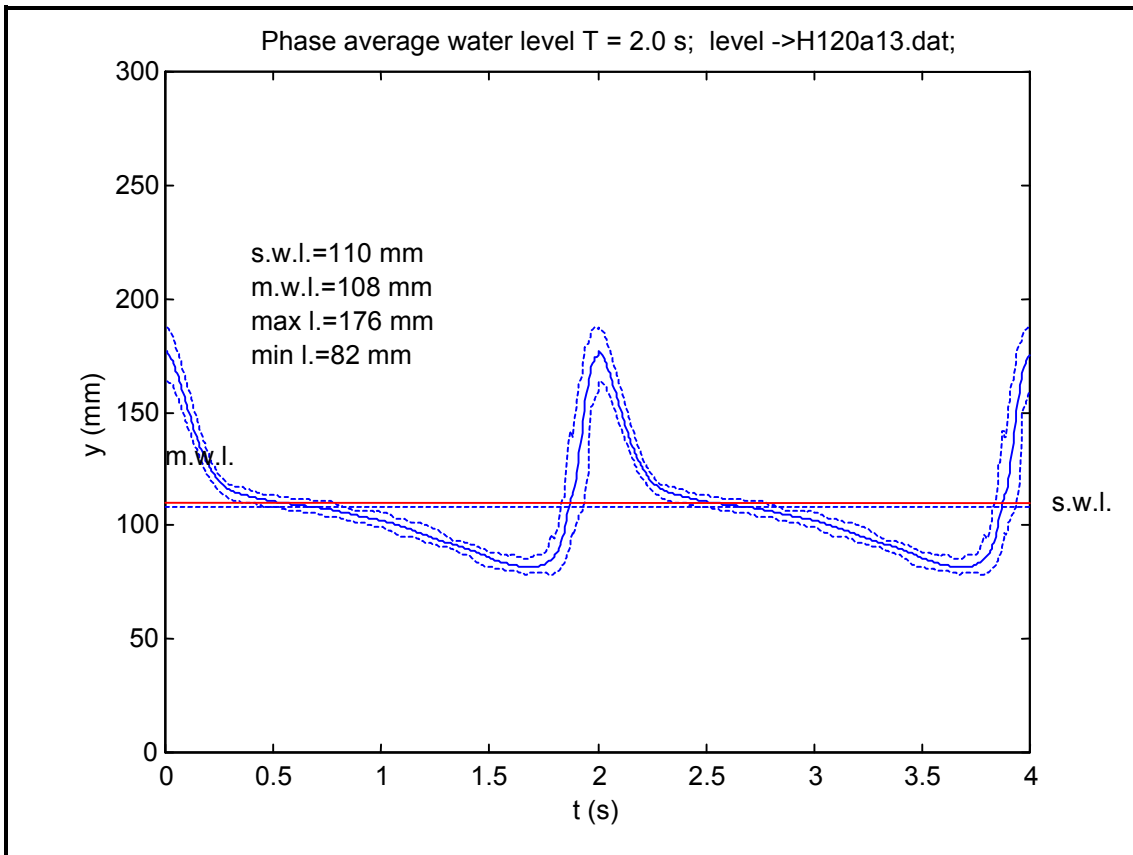

Average water level. Section 3 (A) and 4 (B). T=2.0 s

Series IV-
T=2.0 s

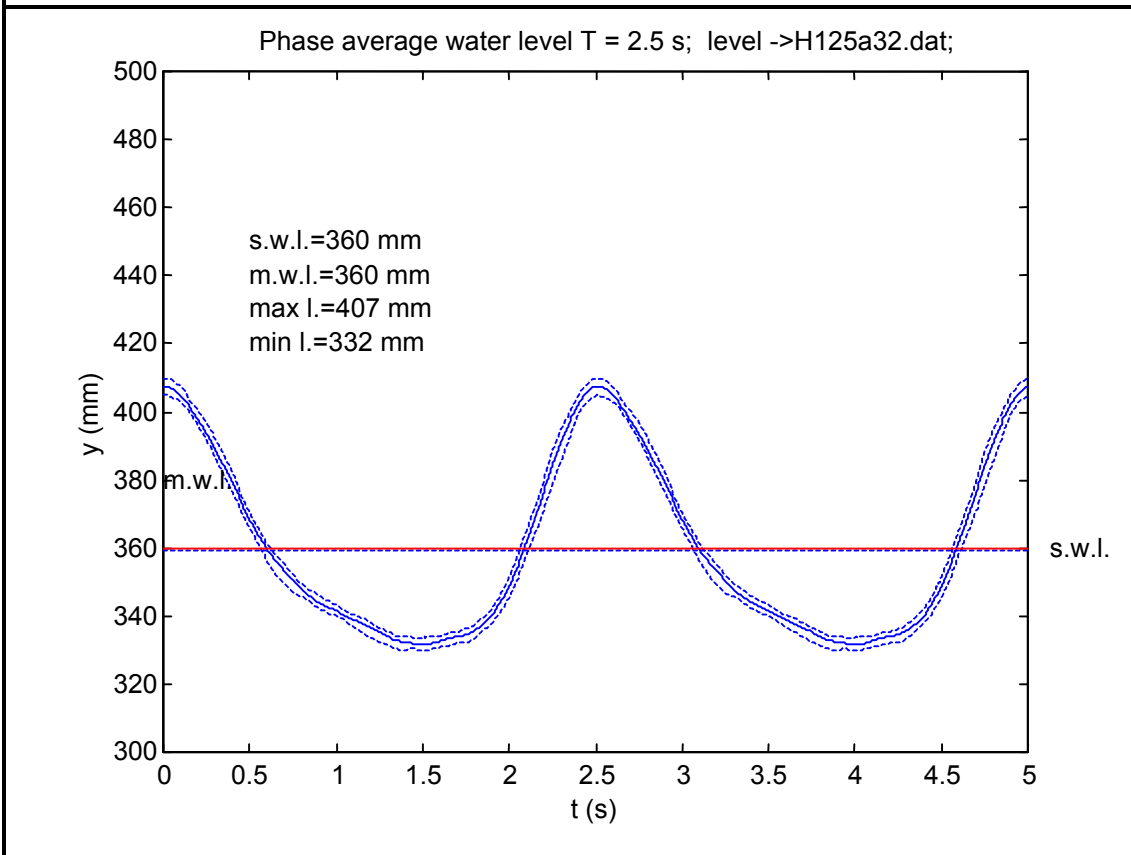
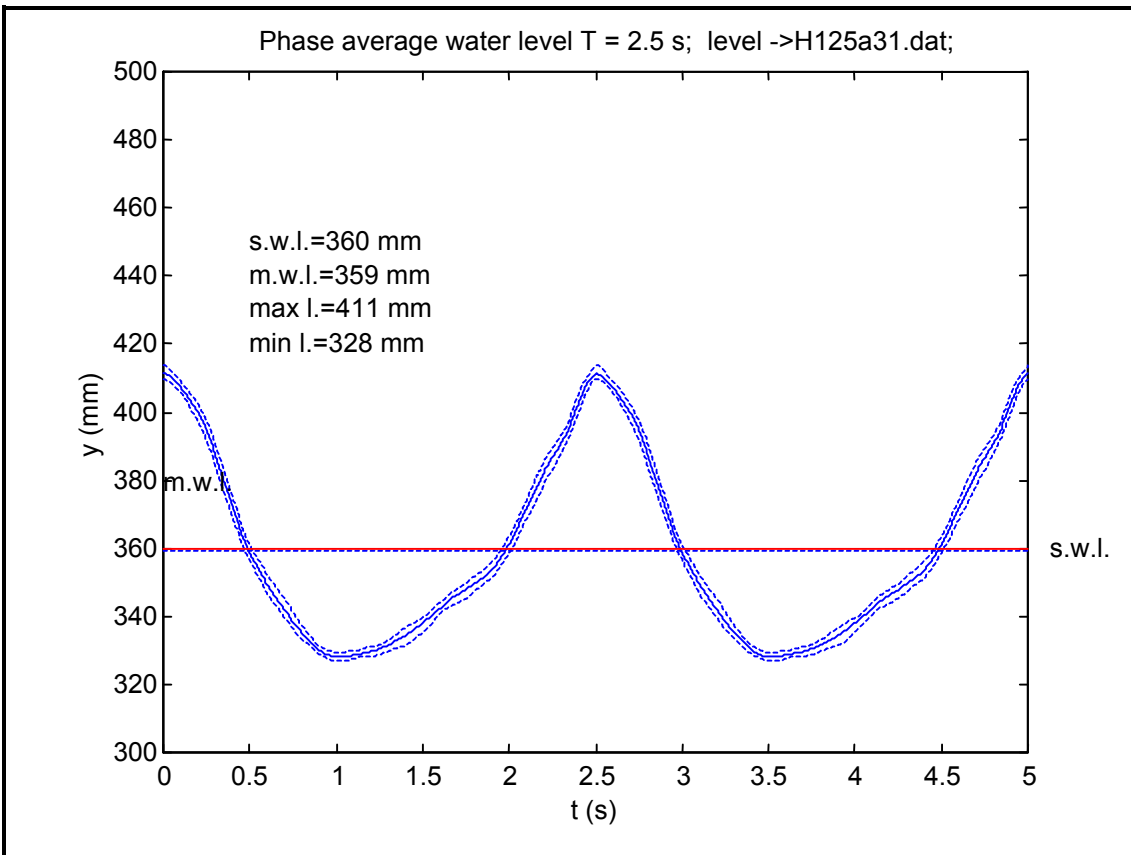

Average water level. Section 1 and 2. T=2.5 s

Series IV-
T=2.5 s

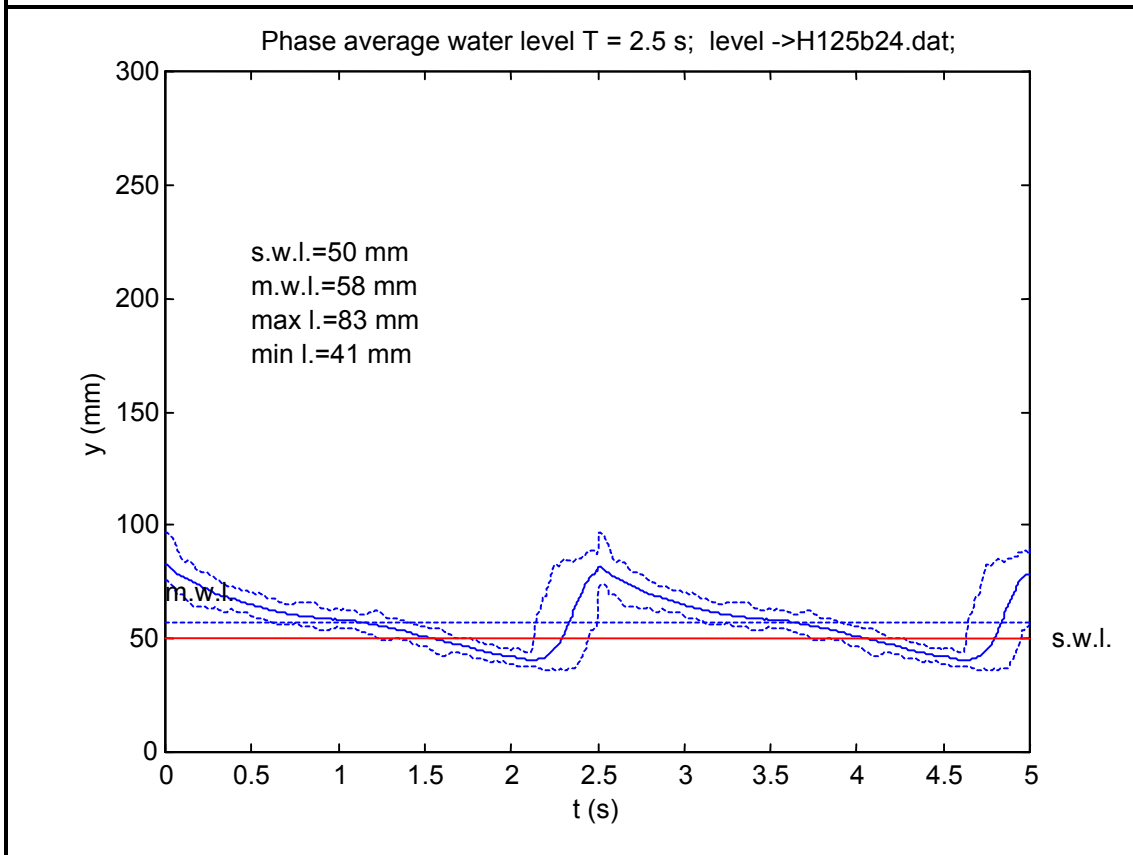
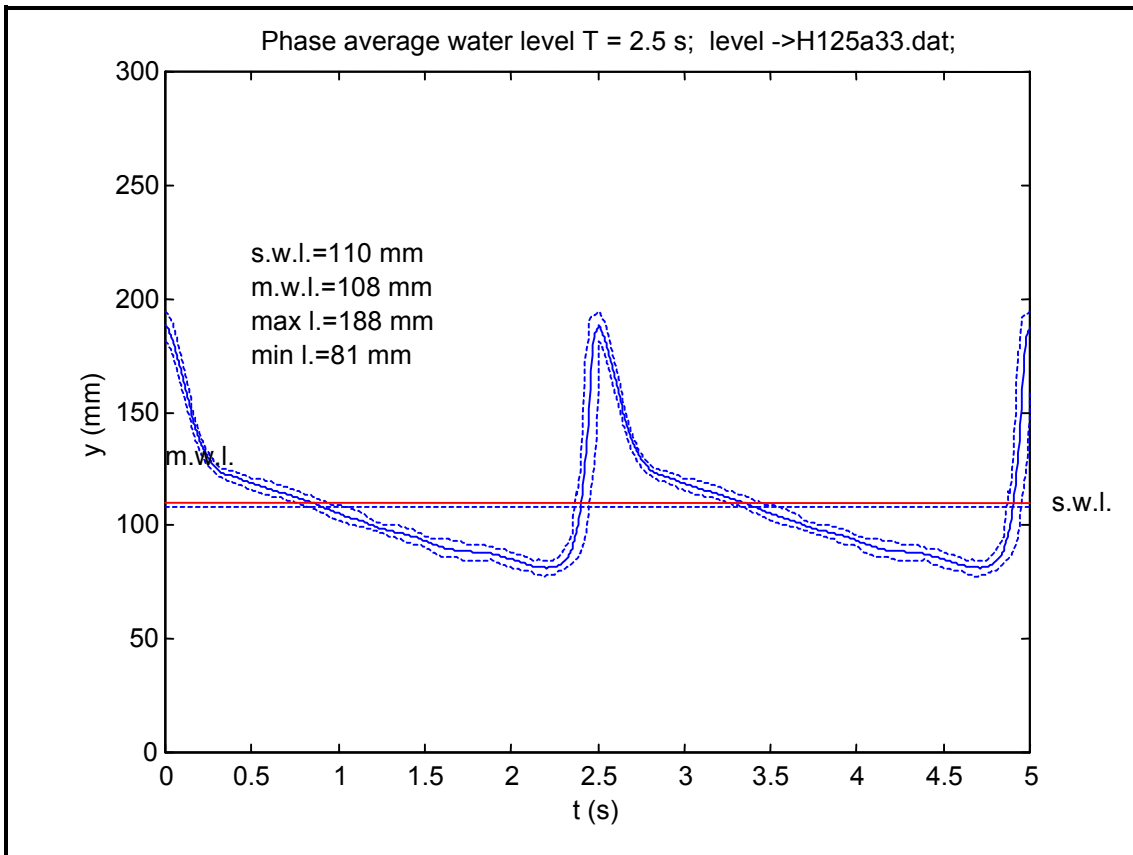

Average water level. Section 3 (A) and 4 (B). T=2.5 s	Series IV- T=2.5 s
---	-------------------------------

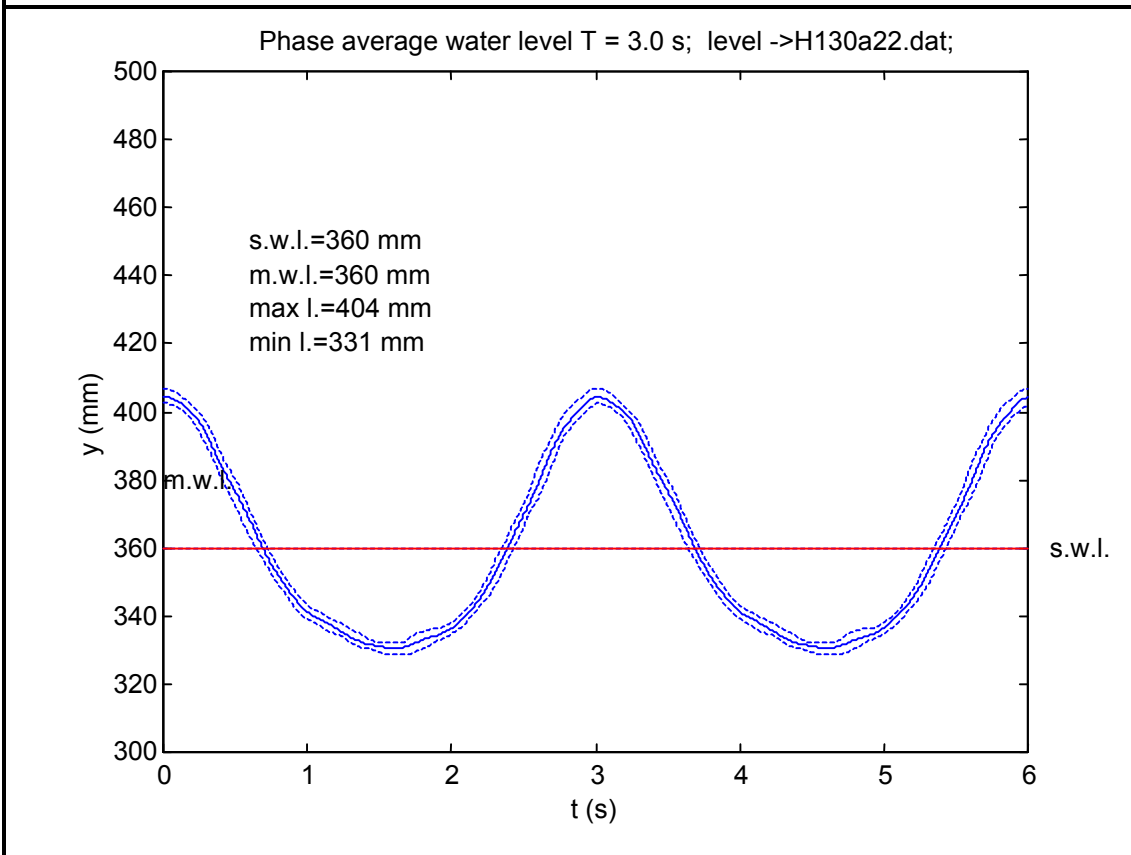
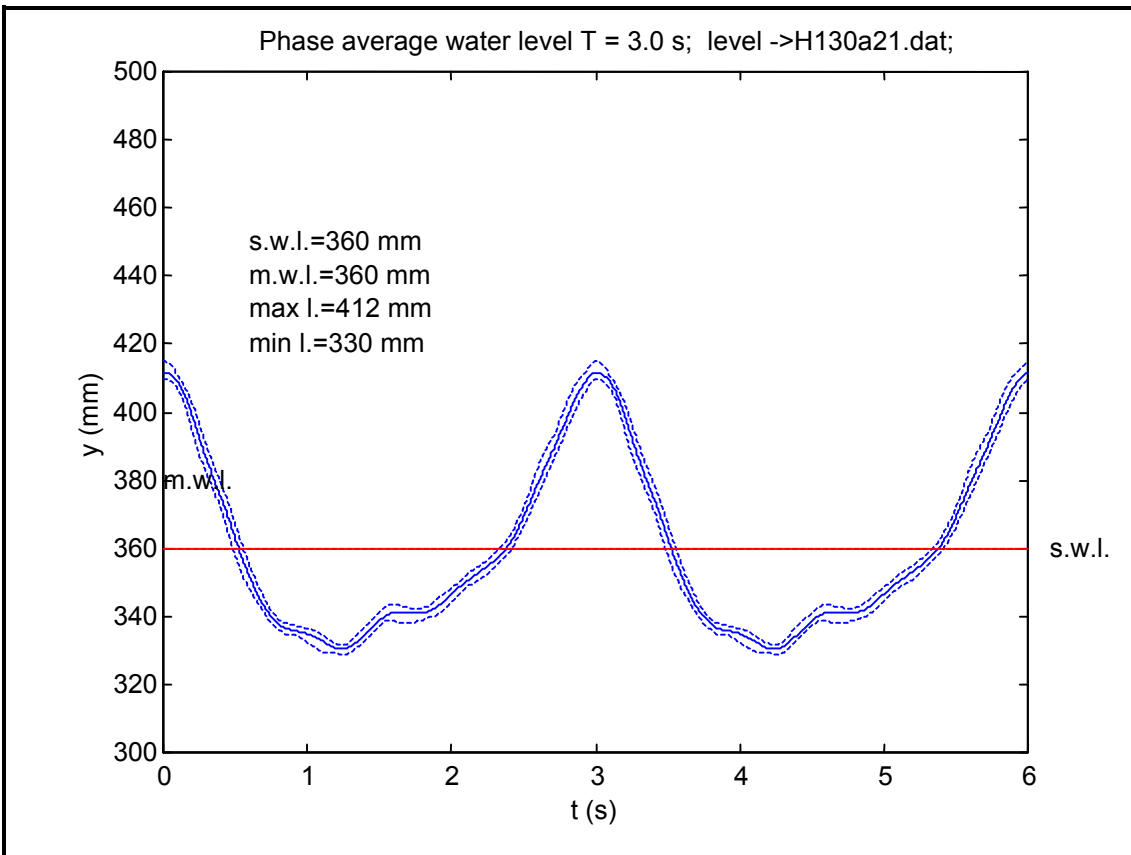

Average water level. Section 1 and 2. T=3.0 s

Series IV-
T=3.0 s

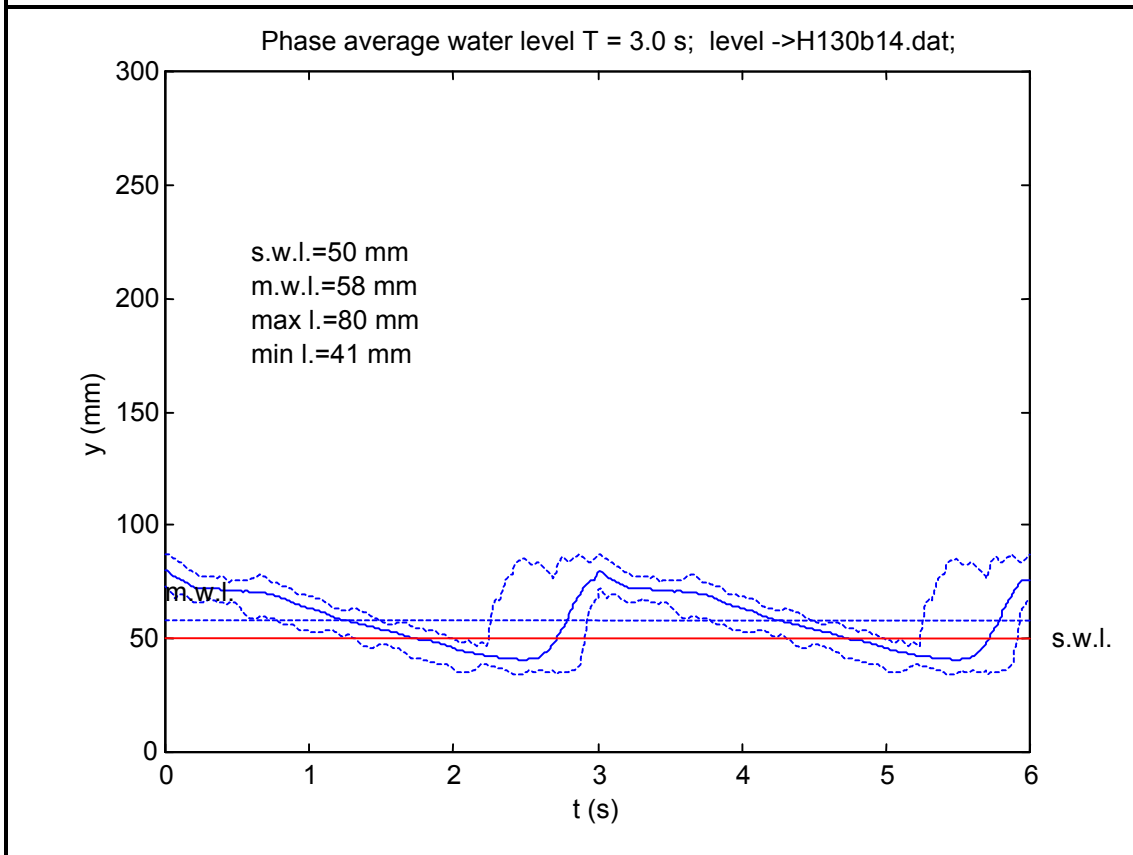
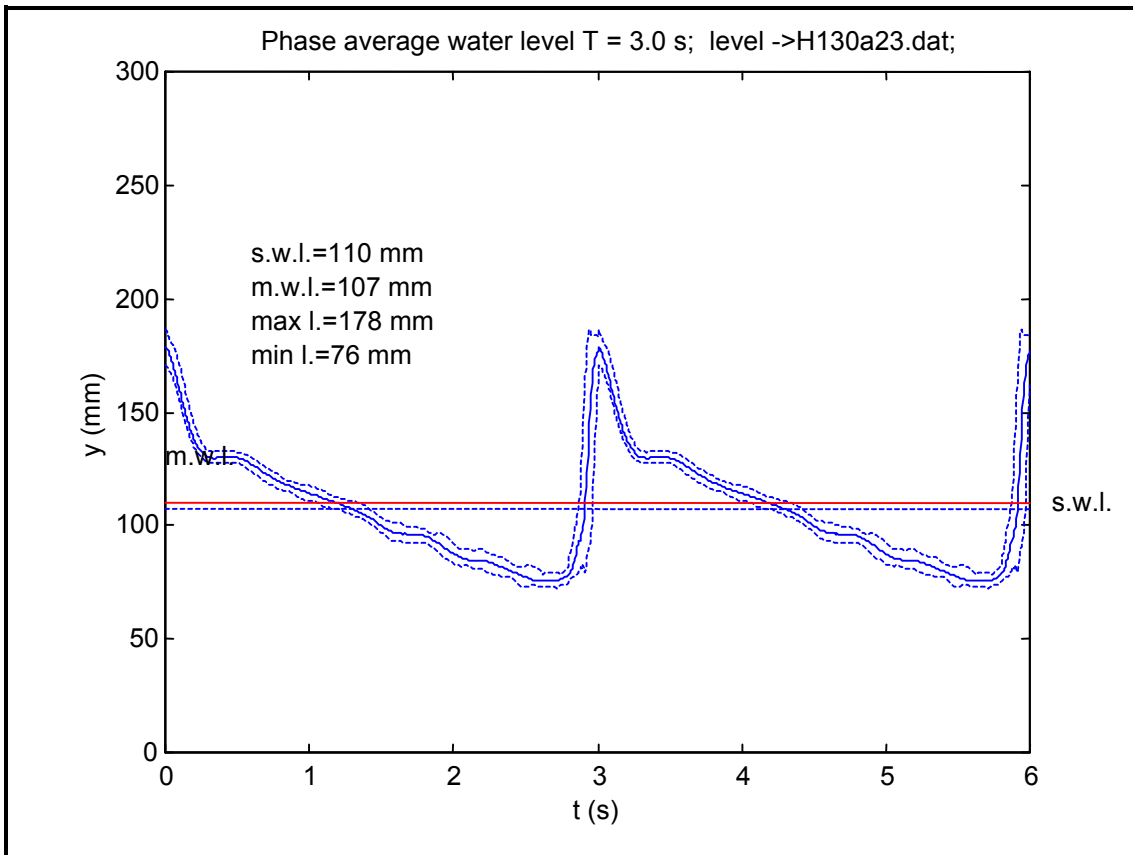

Average water level. Section 3 (A) and 4 (B). T=3.0 s

Series IV-
T=3.0 s

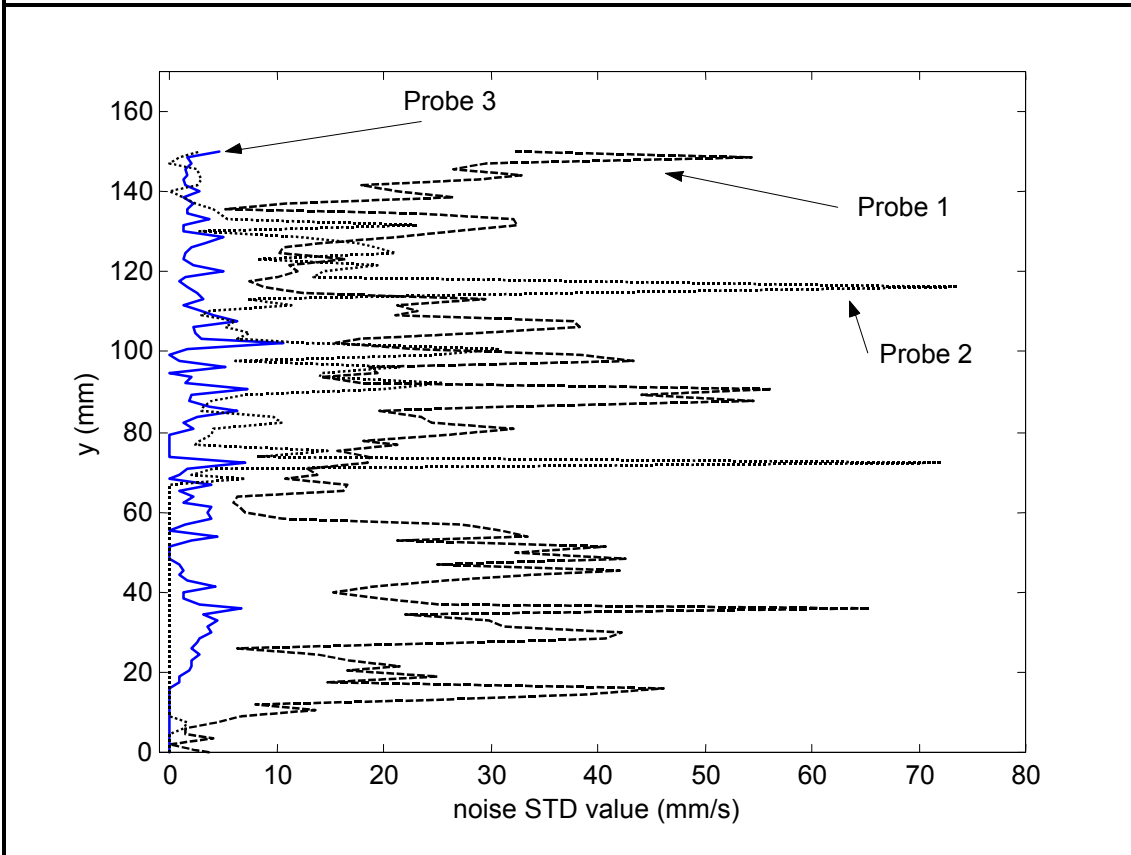
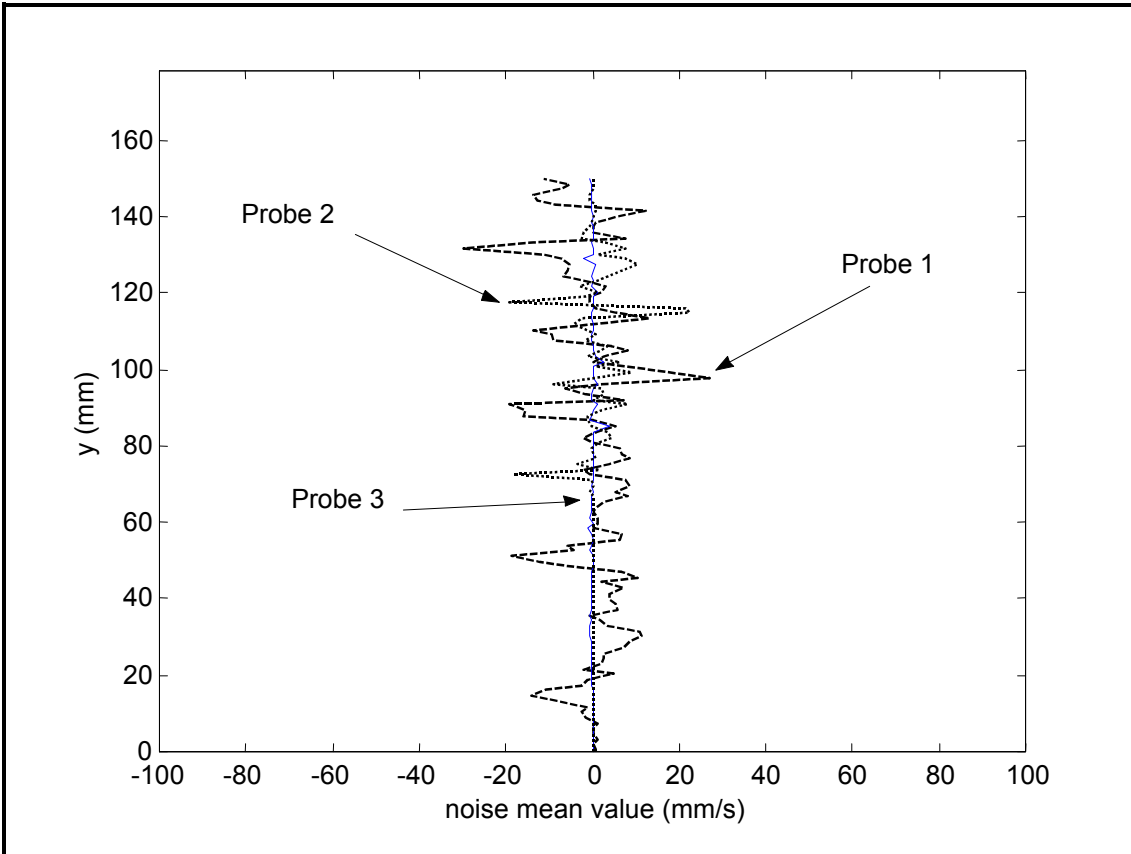

Noise evaluation in Section A.

Series IV

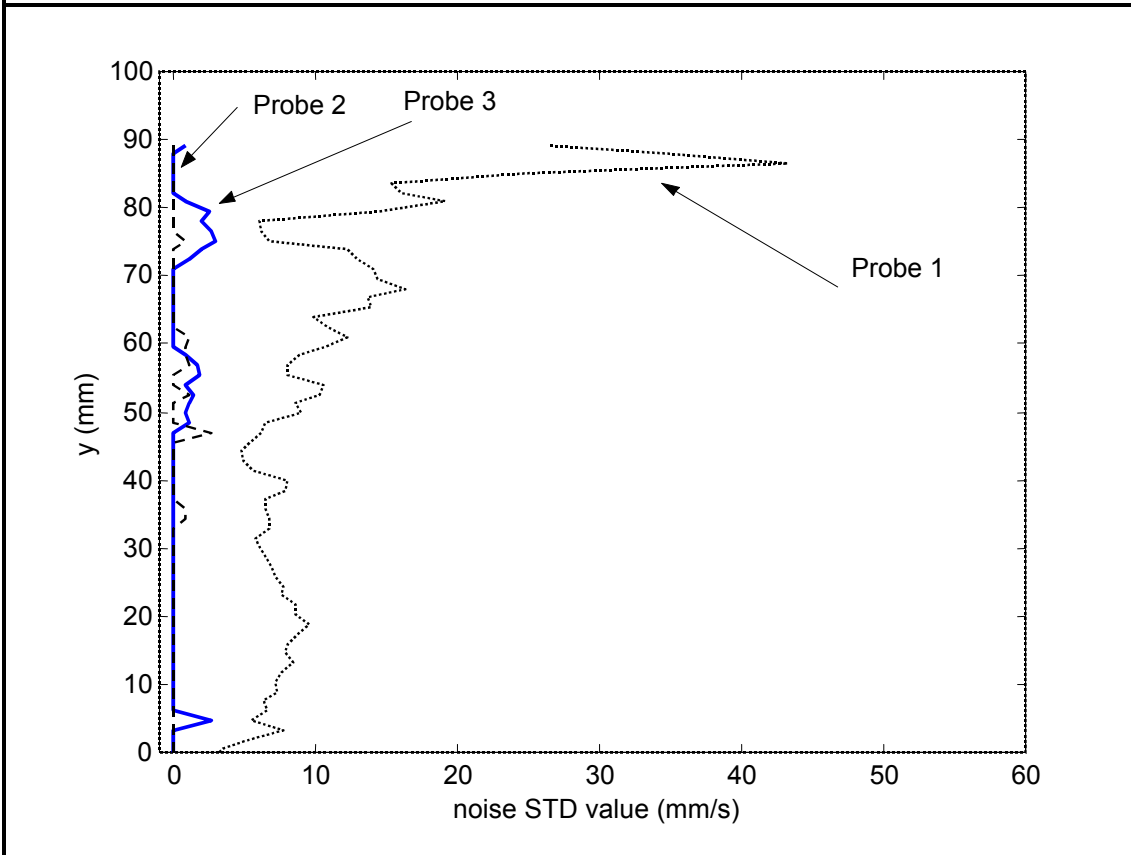
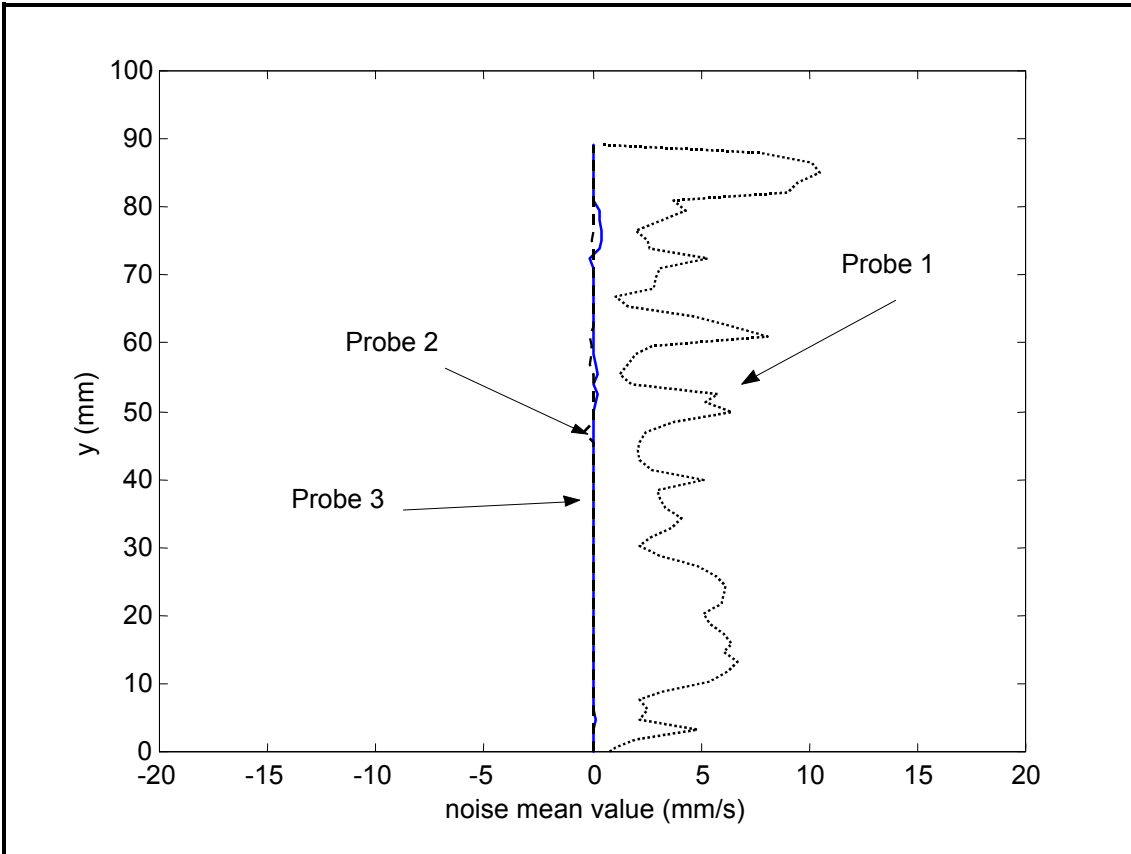

Noise evaluation in Section B.

Series IV

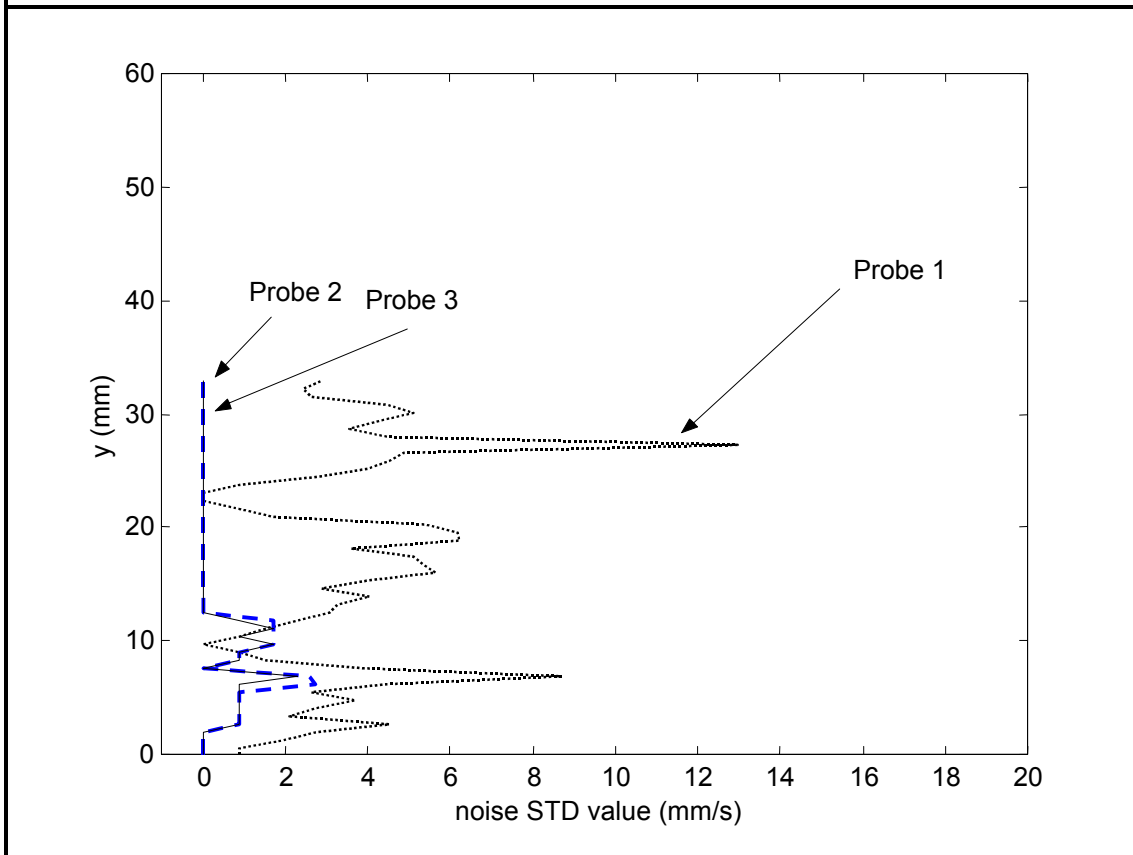
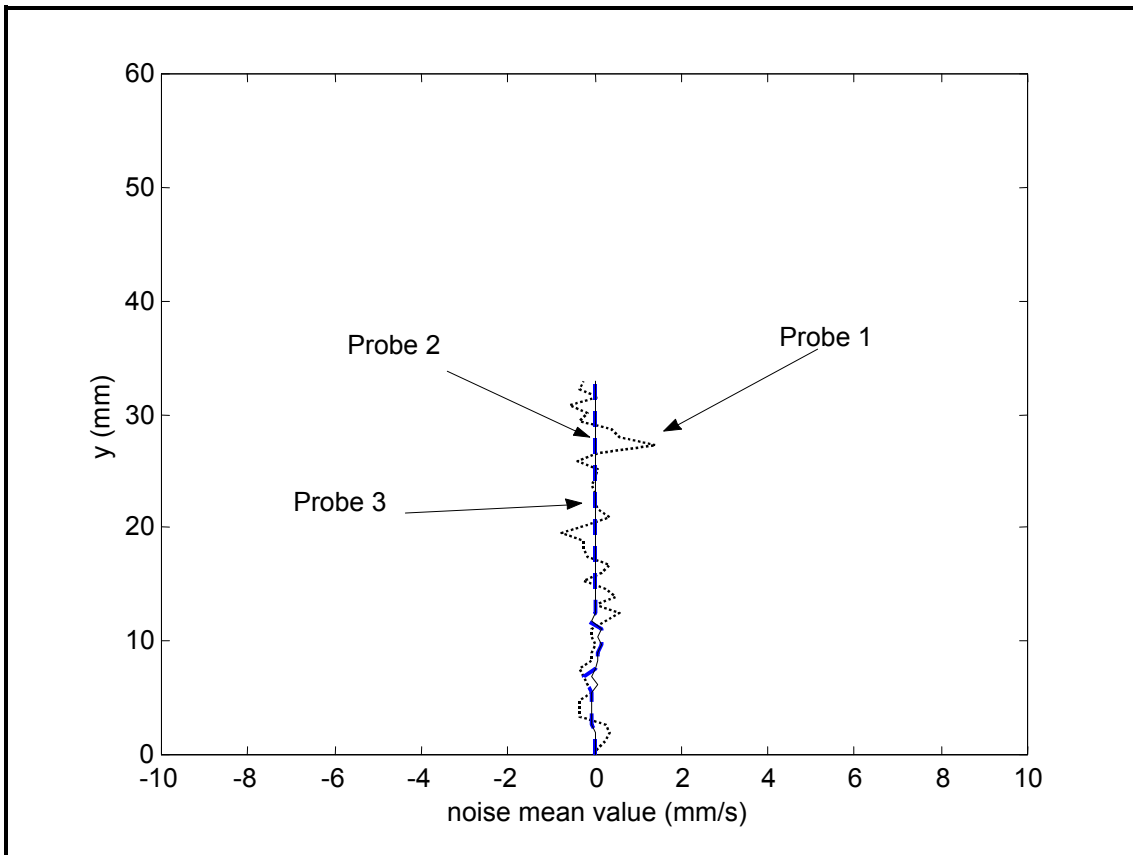

Noise evaluation in Section C.

Series IV

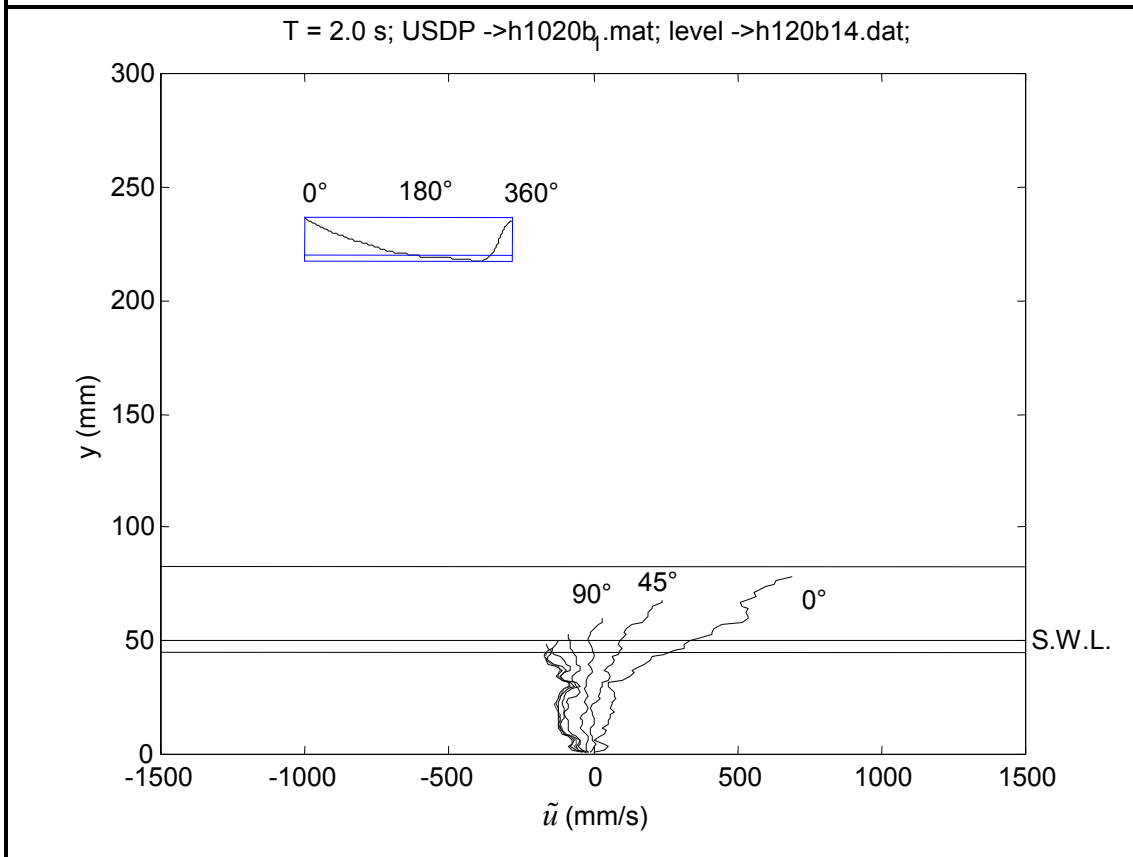
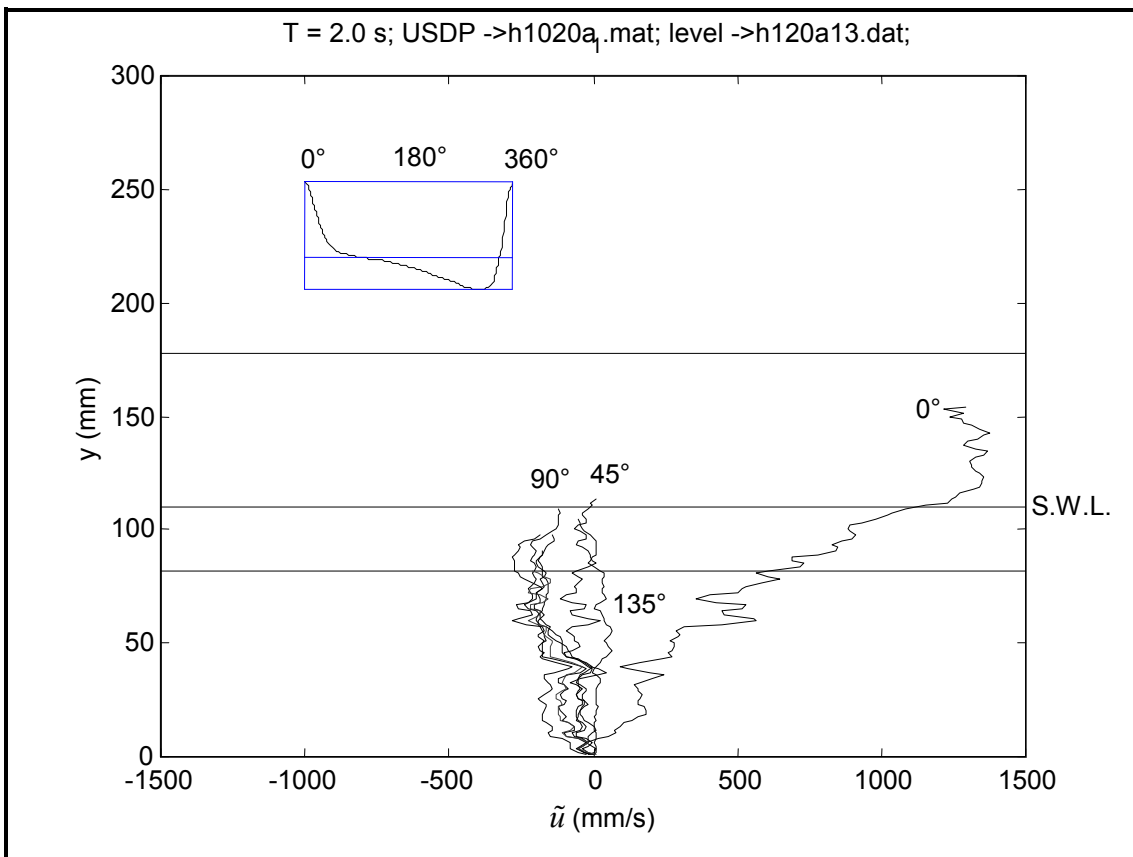

Horizontal velocity profiles. Sections A and B. T=2.0 s

Series IV-
T=2.0 s

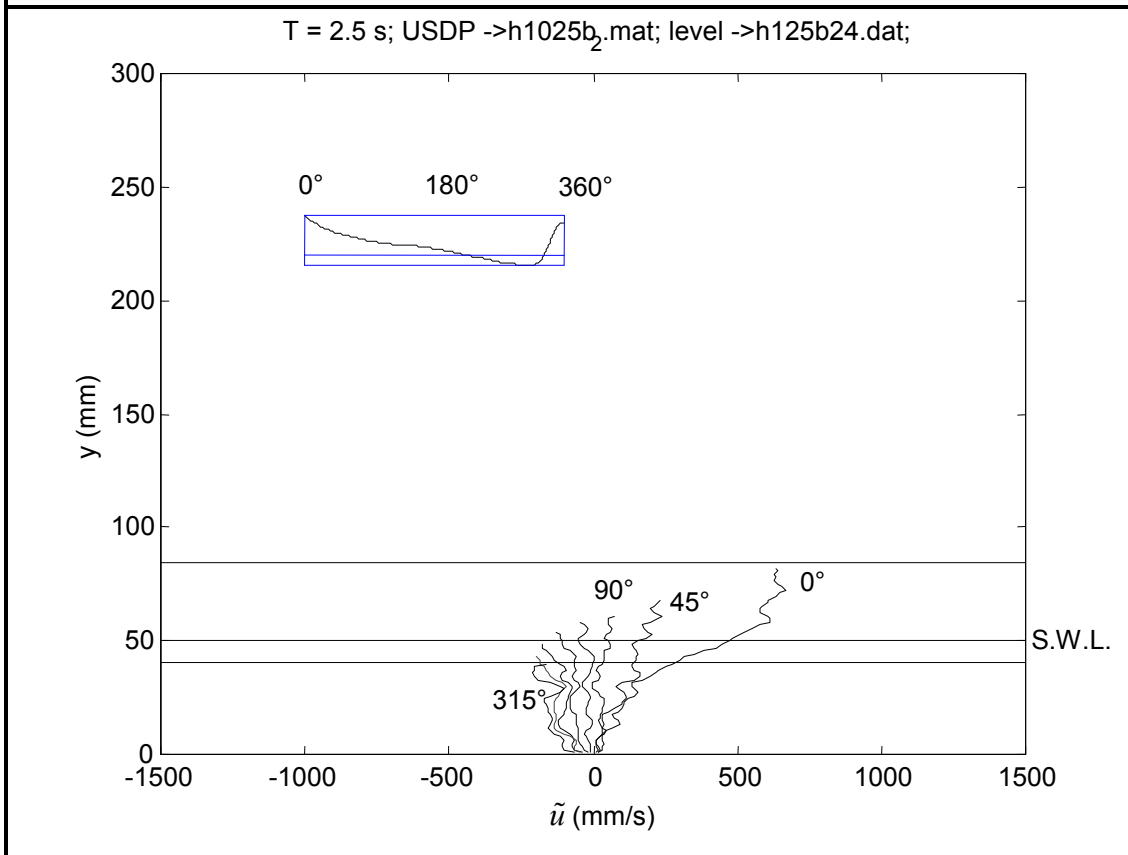
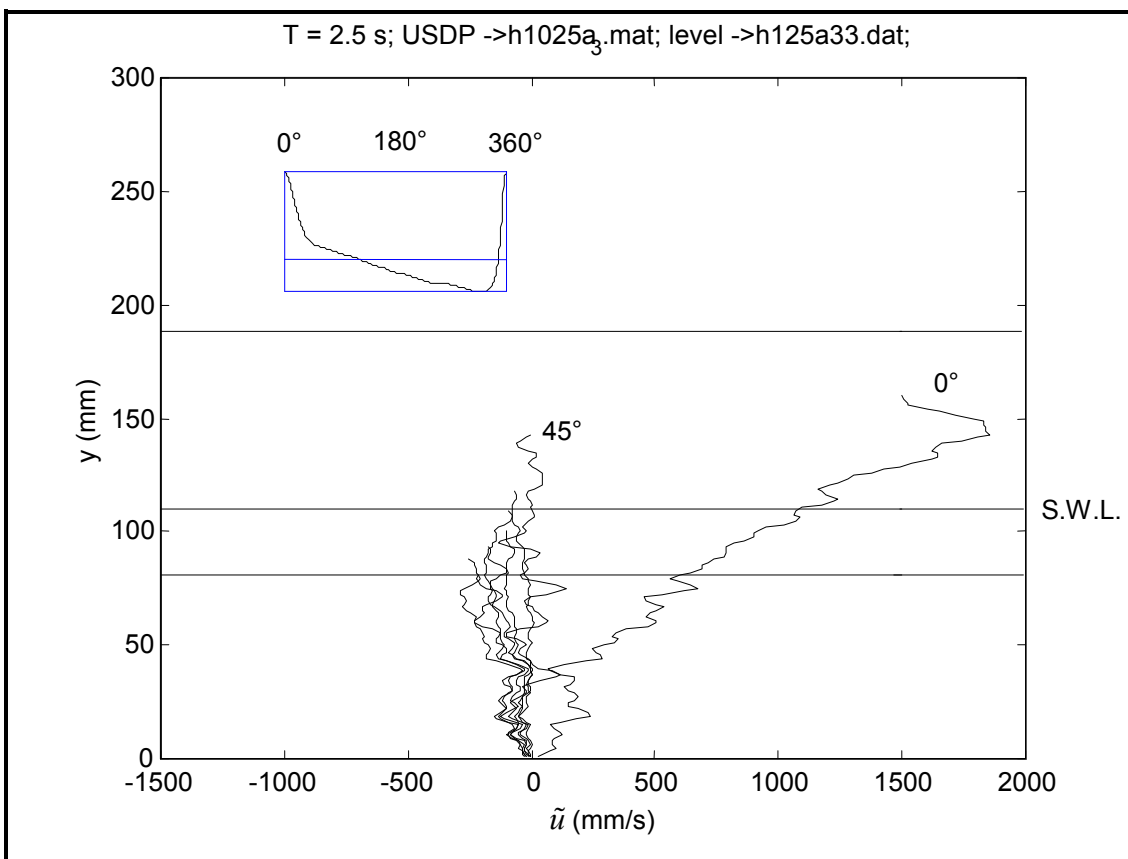

Horizontal velocity profiles. Sections A and B. T=2.5 s

Series IV-
T=2.5 s

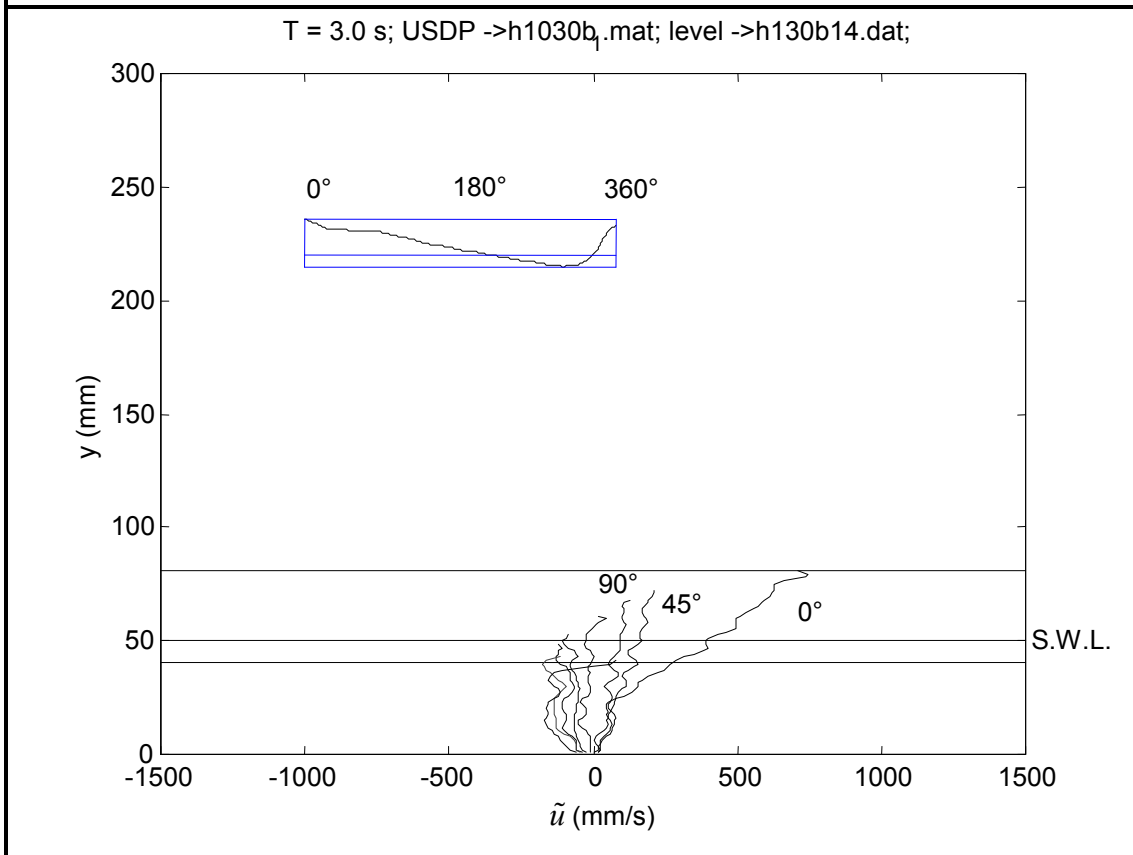
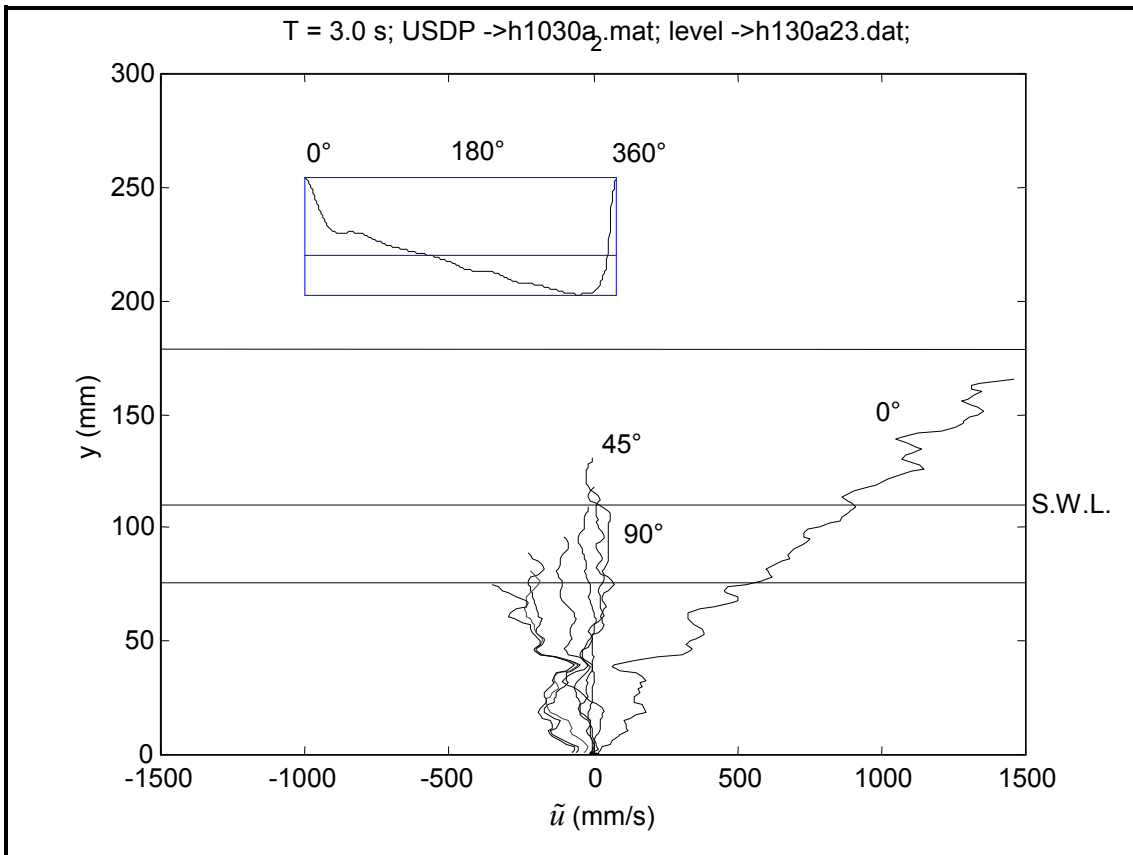

Horizontal velocity profiles. Sections A and B. T=3.0 s

Series IV-
T=3.0 s

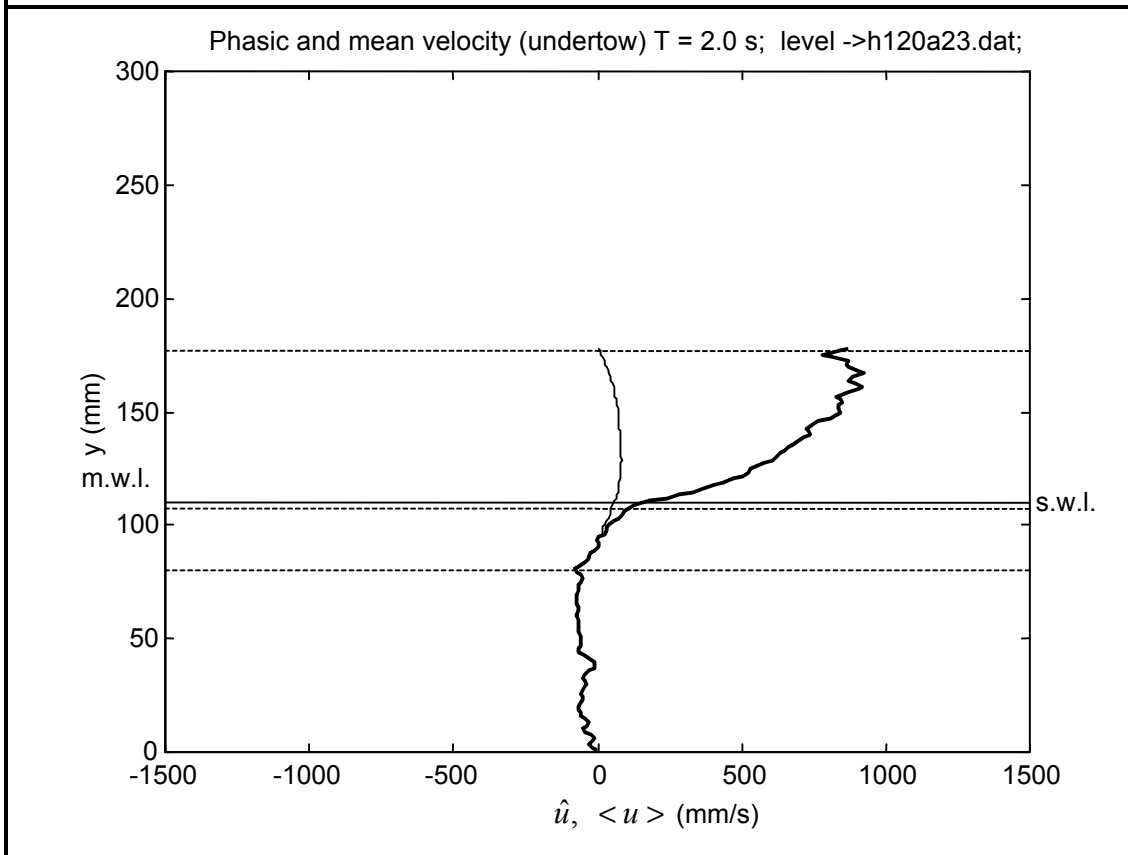
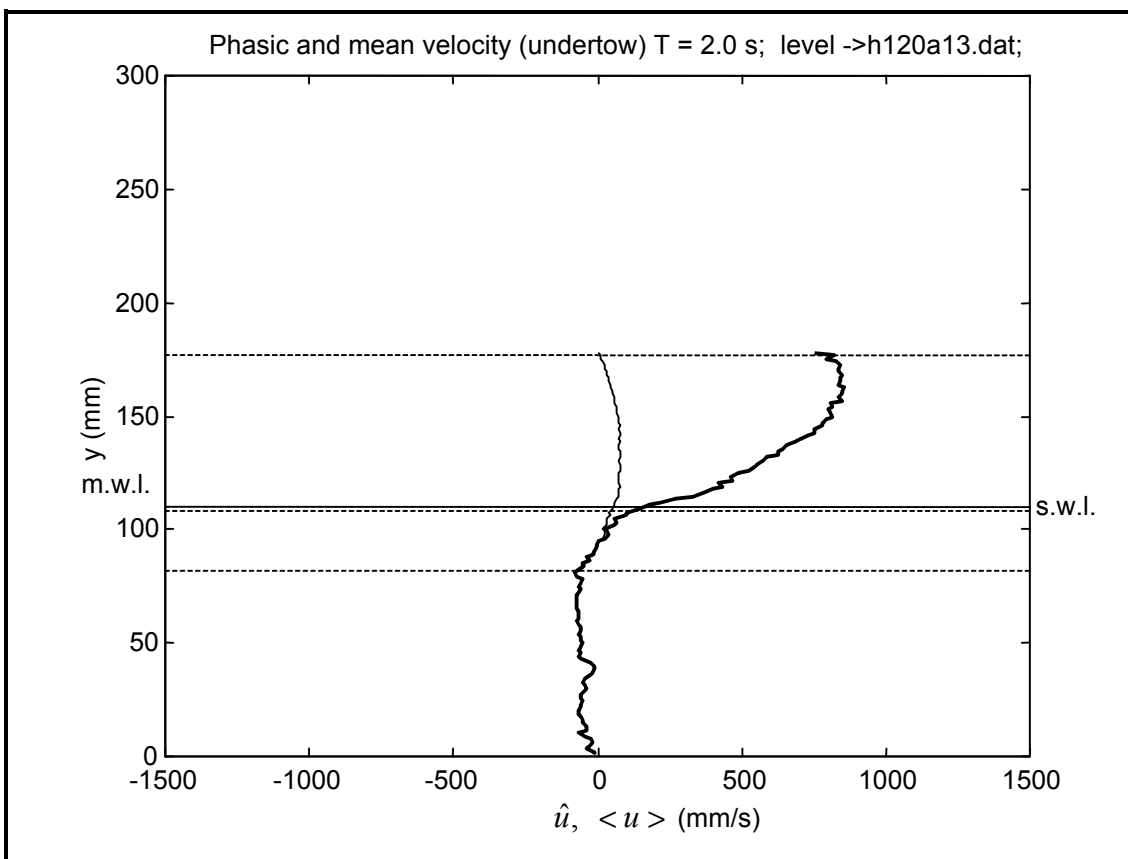

Phasic and mean velocity profiles. Section A. T=2.0 s	Series IV- T=2.0 s
---	-------------------------------------

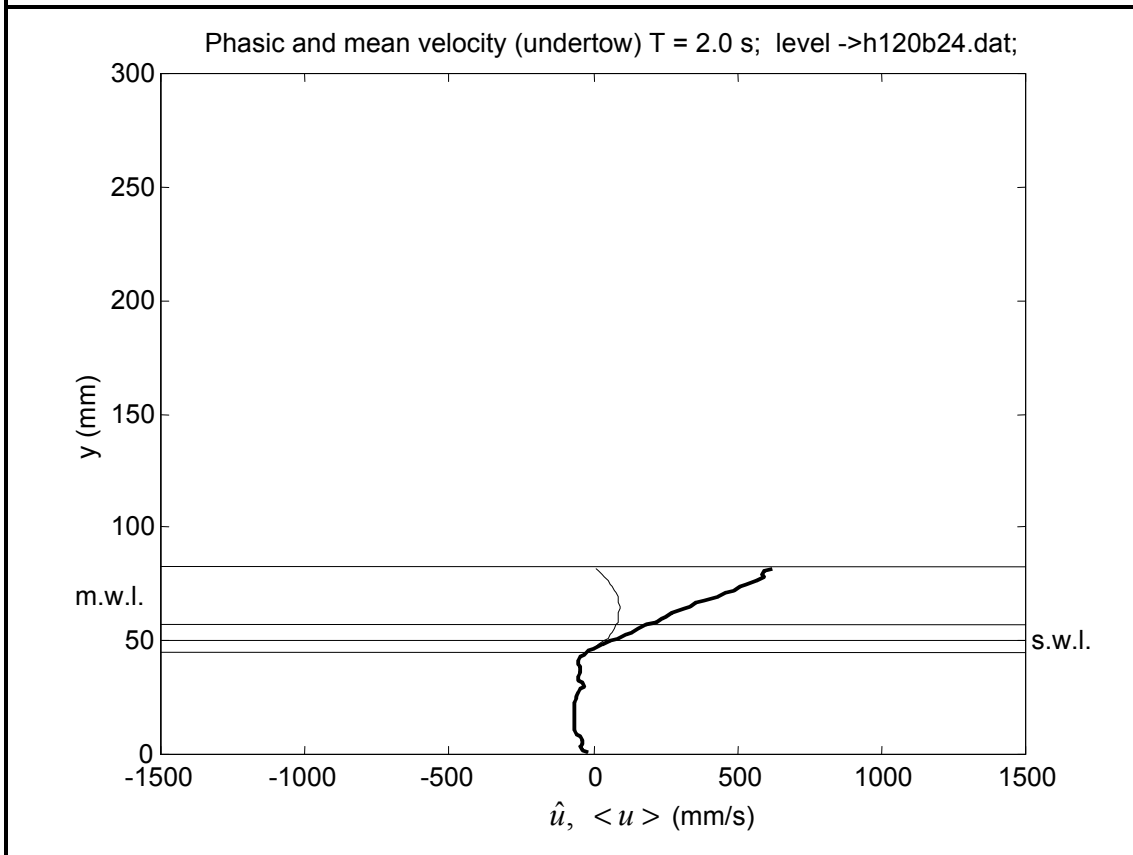
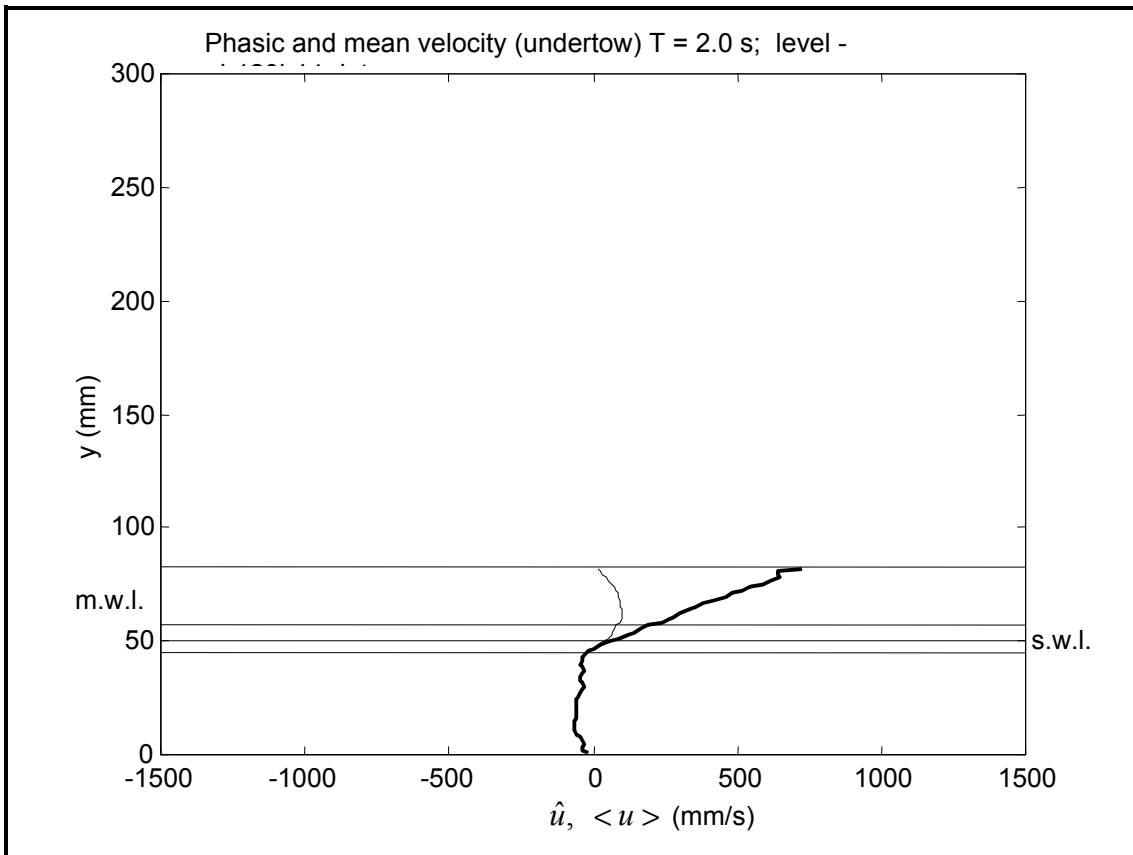

Phasic and mean velocity profiles. Section B. T=2.0 s

Series IV-
T=2.0 s

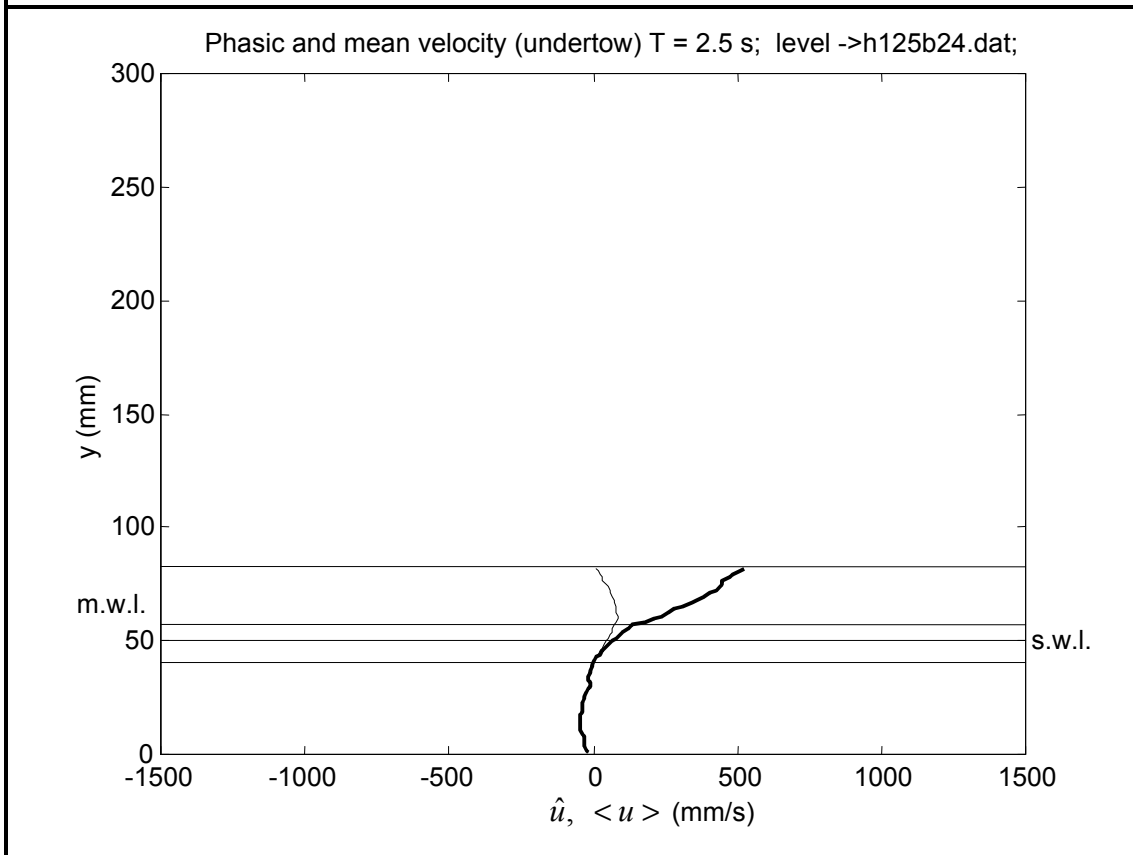
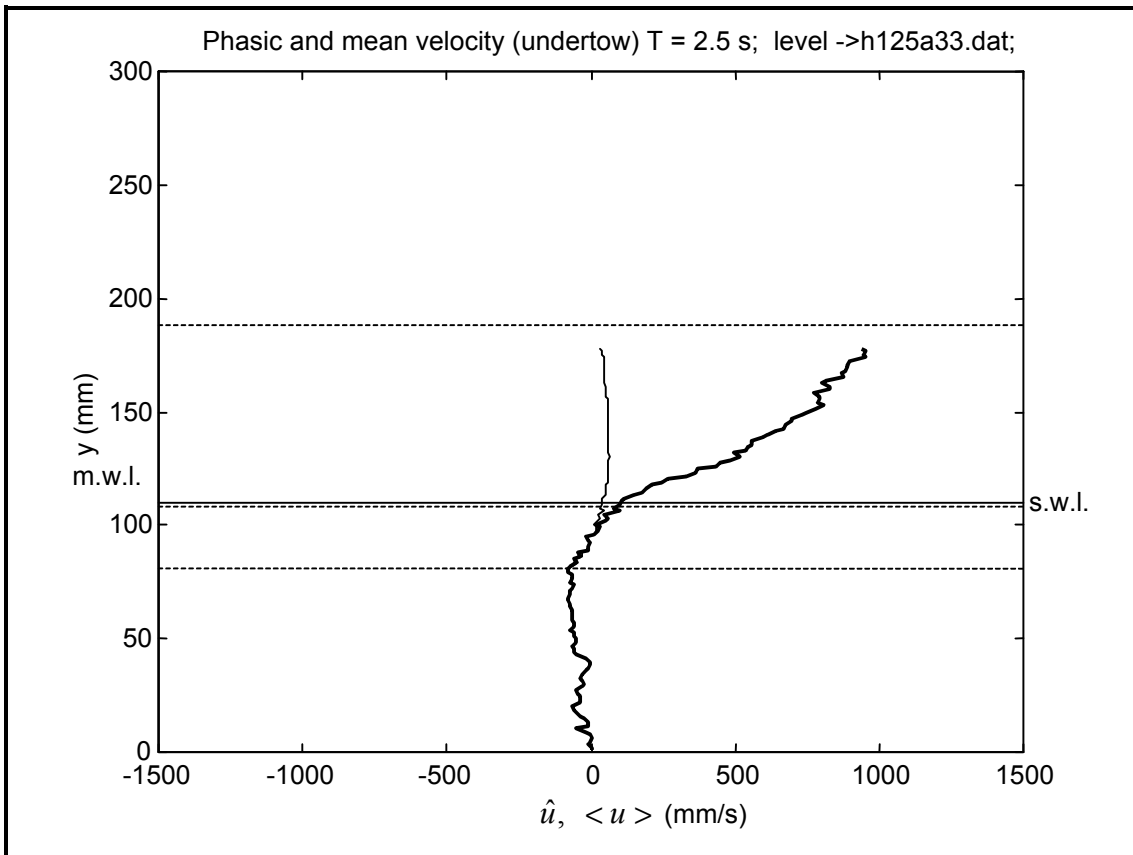

Phasic and mean velocity profiles. Section A and B.
T=2.5 s

Series IV-
T=2.5 s

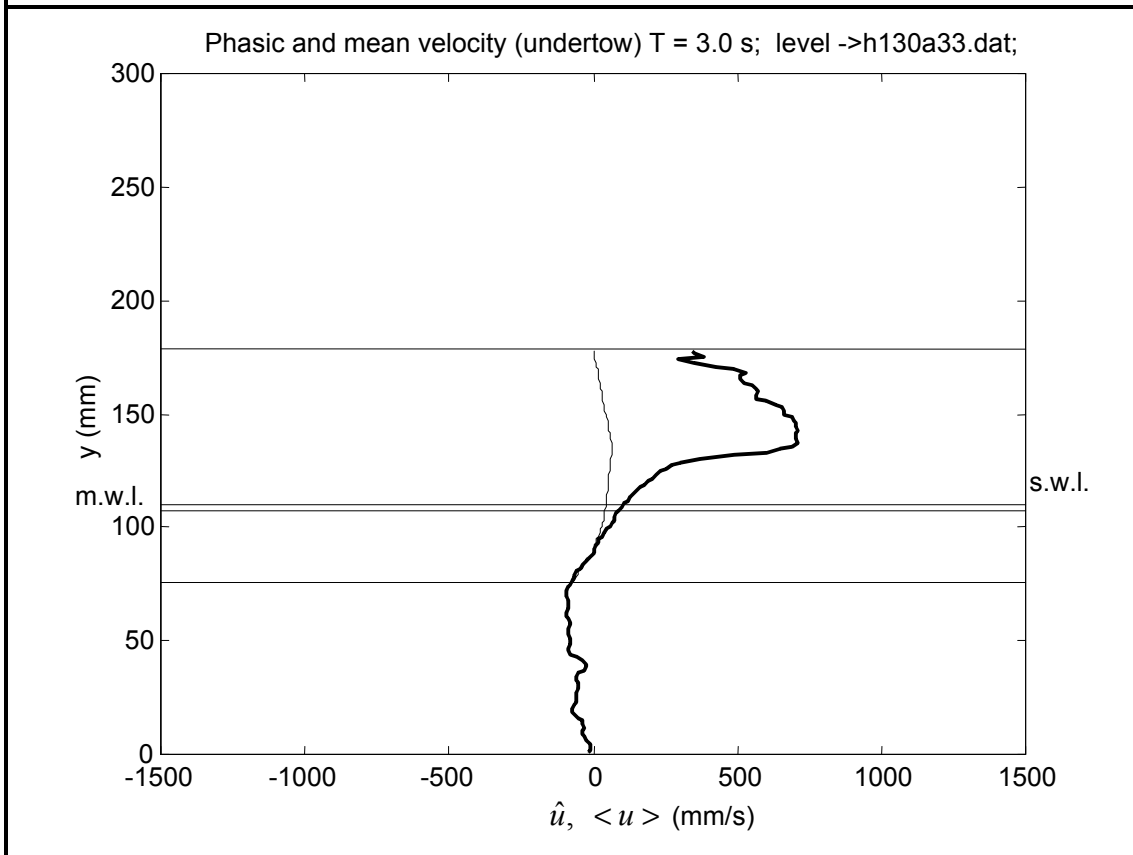
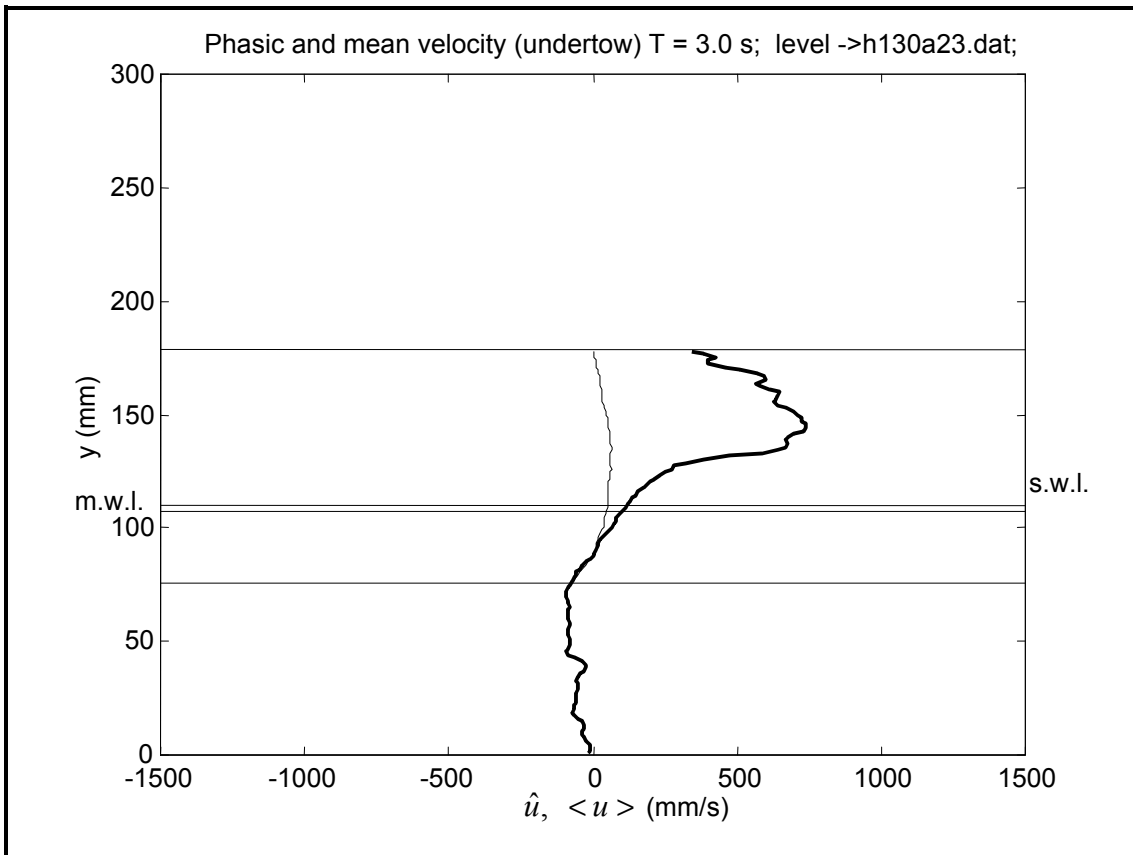

Phasic and mean velocity profiles. Section A. T=3.0 s

Series IV-
T=3.0 s

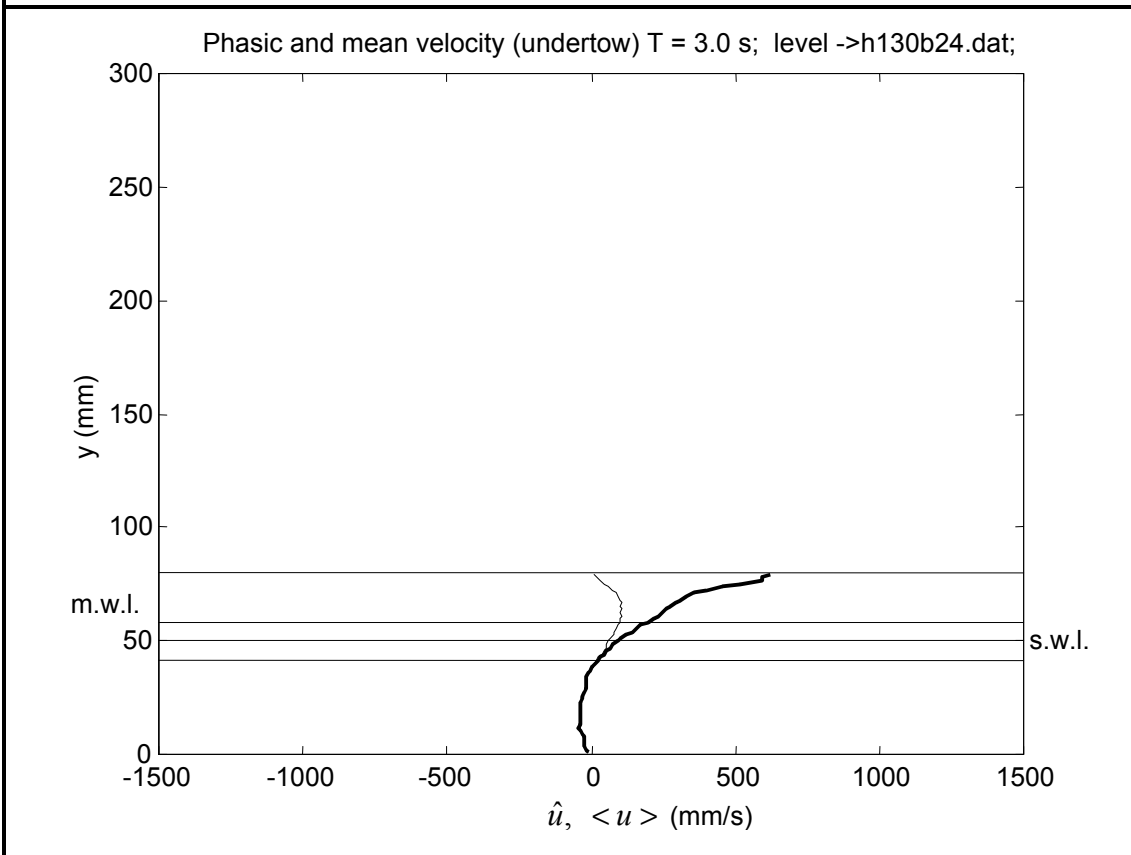
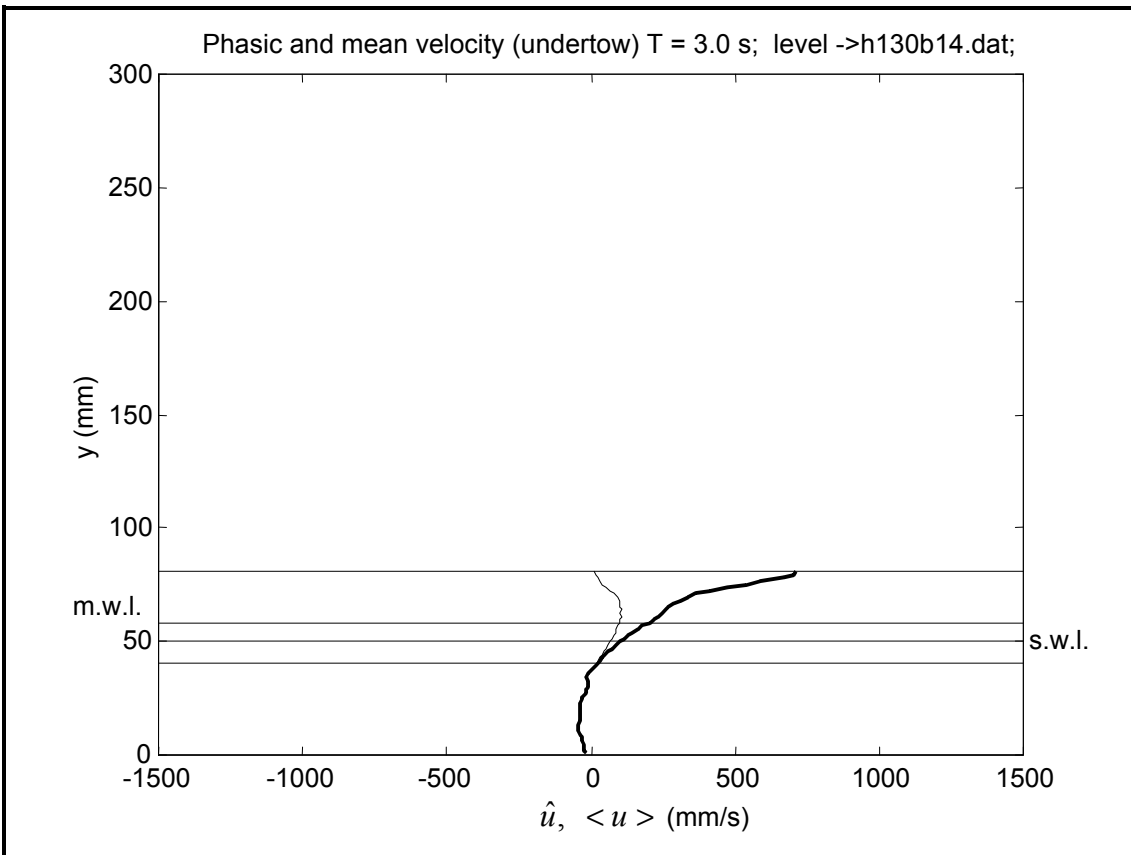

Phasic and mean velocity profiles. Section B. T=3.0 s

Series IV-
T=3.0 s

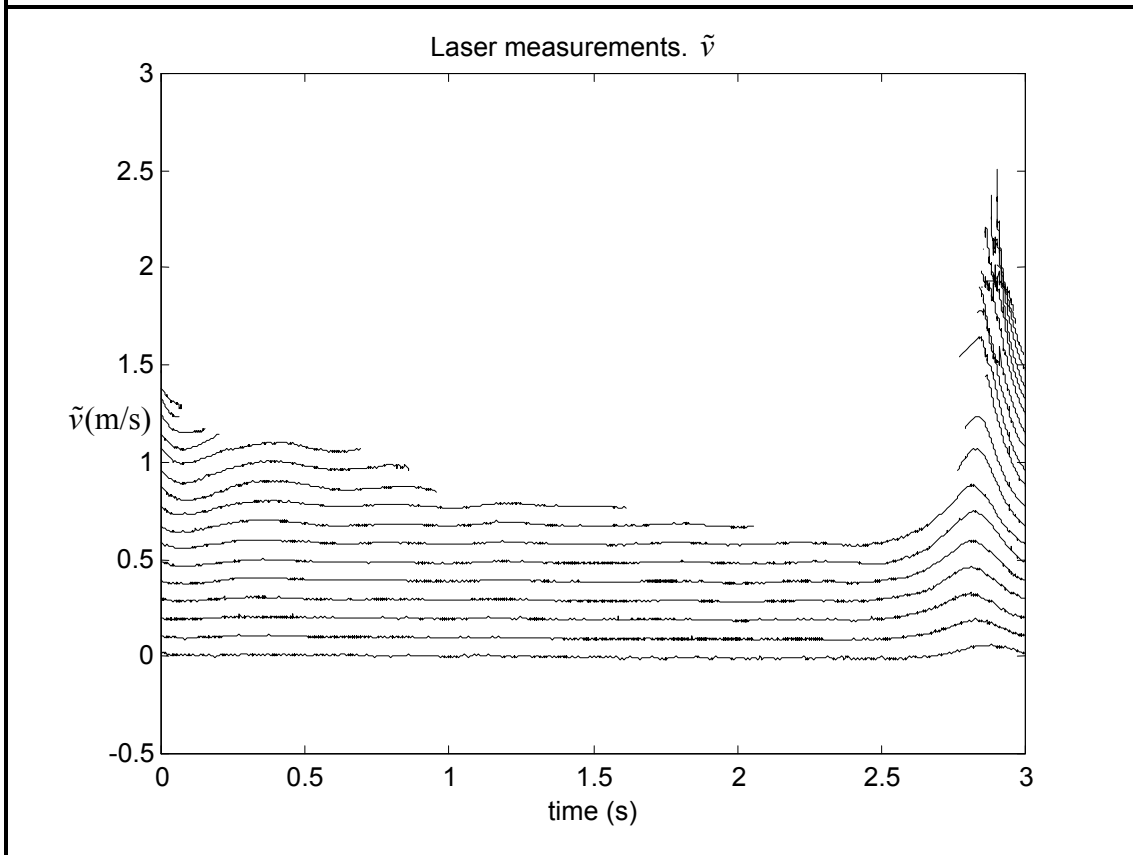
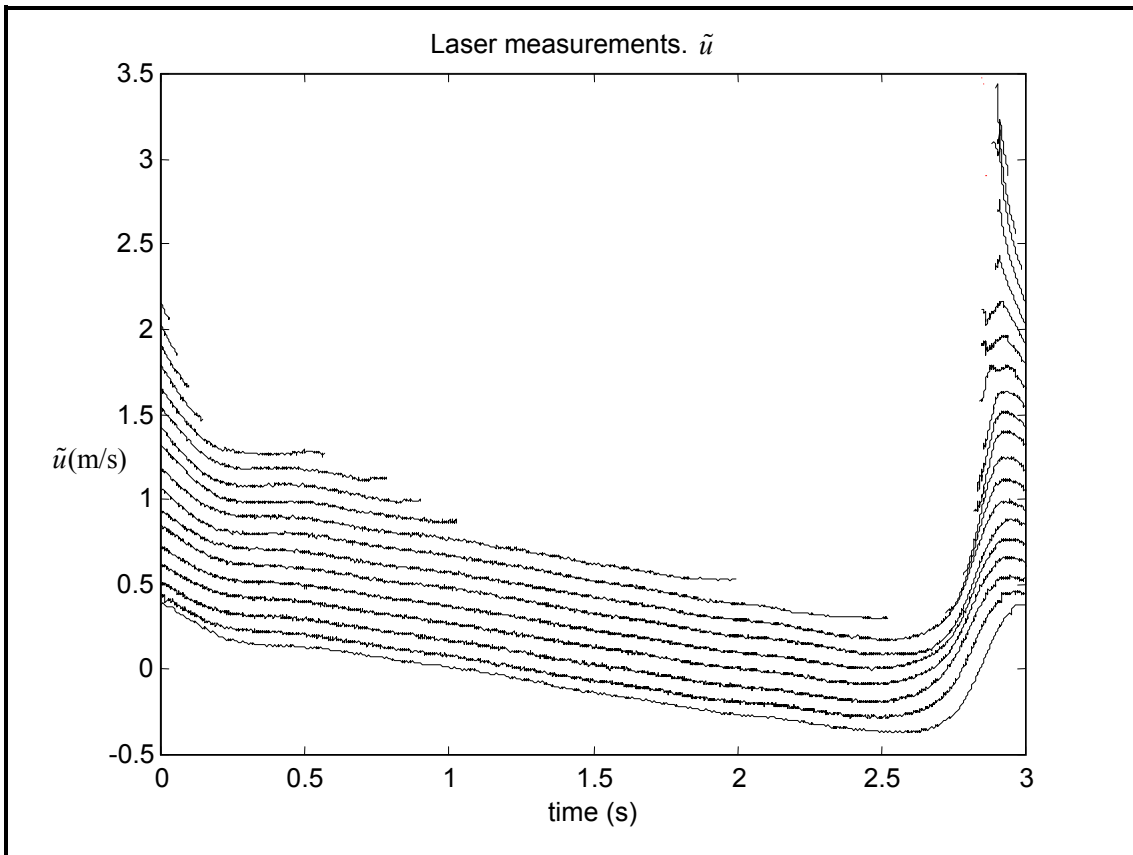

Laser measurements phase average velocities at different levels. Each curve has been shifted upward by 0.1 with respect to the previous.

Laser series

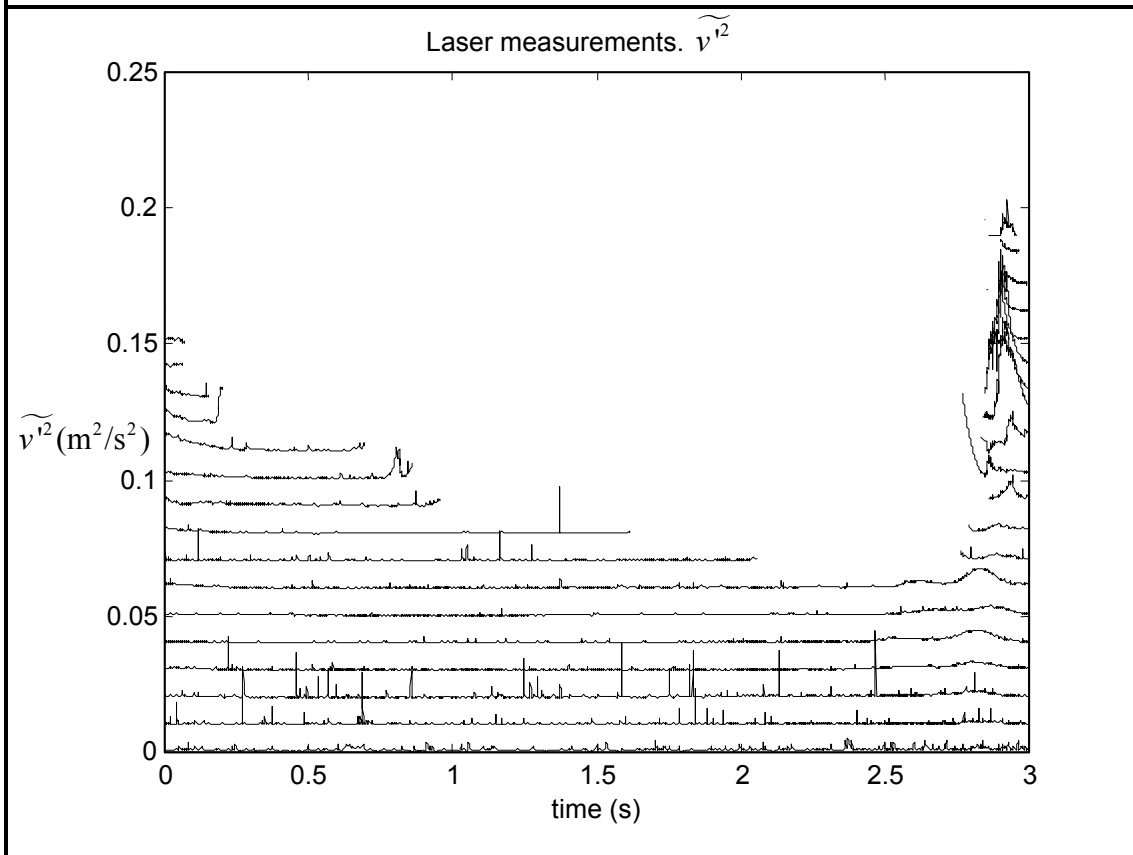
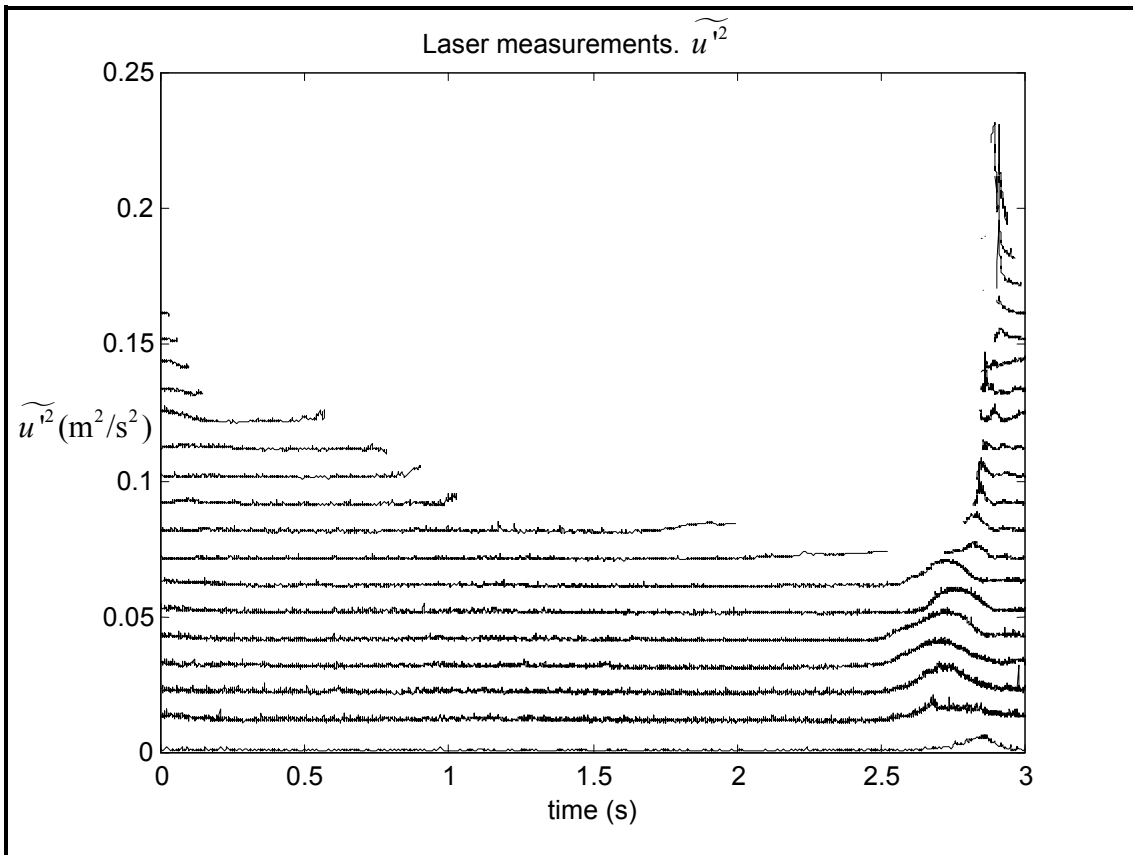

Laser measurements phase average fluctuations at different levels. Each curve has been shifted upward by 0.01 with respect to the previous.

Laser series

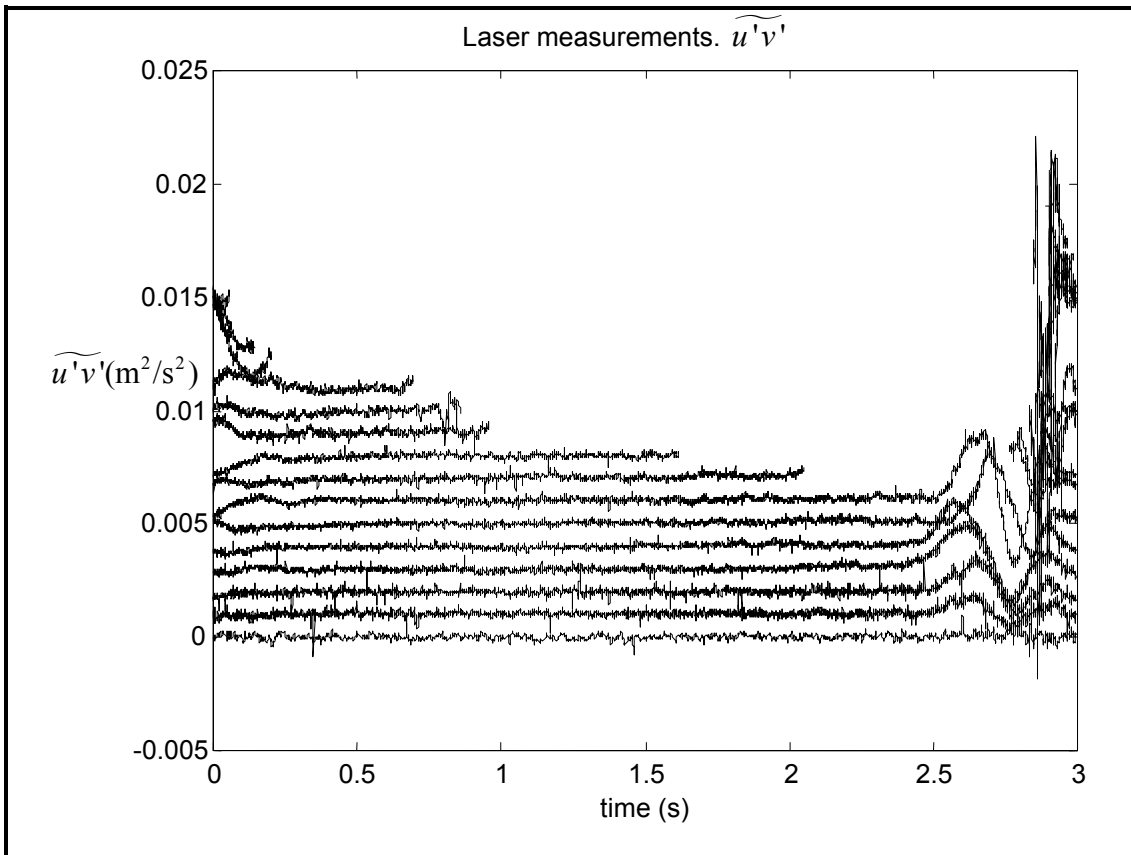

Intentionally blank

Phase average Reynold's stress at different levels. Each curve has been shifted upward by 0.001 with respect to the previous.

Laser series

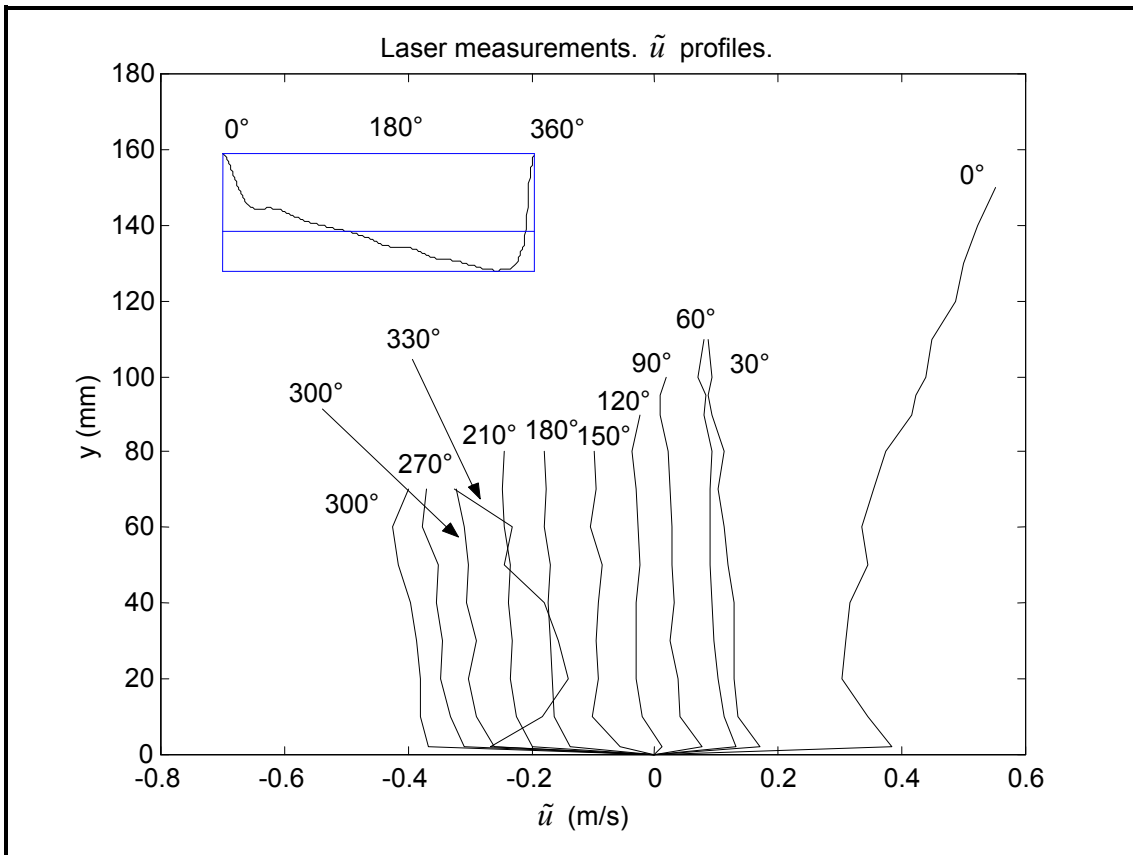

Intentionally blank

ANNEX 3

UPr
UCa

Measurements of breaking waves and bores through a USD velocity profiler. Annex 3

A3 - 2

File list

Directory D:\calibration

CA040700 CAL	201
CA050700 CAL	208
CA260600 CAL	196
CA270600 CAL	196
CA280600 CAL	196
CA300600 CAL	204
LEV0021 DAT	209.106
LEV0022 DAT	207.672
LEV0023 DAT	312.528
LEV0024 DAT	109.226
LEV0025 DAT	125.730
LIV0011 DAT	210.909
LIV0012 DAT	126.888
LIV0013 DAT	128.472
LIV0014 DAT	86.685
LIV0015 DAT	89.076
LIV0031 DAT	86.400
LIV0032 DAT	86.400
LIV0033 DAT	178.723
LIV0034 DAT	173.399
LIV0035 DAT	86.400
LIV0051 DAT	86.400
LIV0052 DAT	153.434
LIV0053 DAT	86.400
LIV0054 DAT	88.996
LIV0055 DAT	86.400
LIV0071 DAT	86.543
LIV0072 DAT	127.749
LIV0073 DAT	112.921
LIV0074 DAT	111.194
LIV0075 DAT	86.400
LIV0081 DAT	113.834
LIV0082 DAT	254.216
LIV0083 DAT	279.681
LIV0084 DAT	86.400
LIV0085 DAT	86.400

36 file 4.065.783 byte

Directory D:\signal\Linear

ETA1220 DAT	648.018
ETA1225 DAT	648.018
ETA1230 DAT	648.018
SIG1220 DAT	216.051
SIG1225 DAT	216.051
SIG1230 DAT	216.051

6 file 2.592.207 byte

Directory D:\signal\Order5

ETA1020 DAT	648.018
ETA1025 DAT	648.018
ETA1030 DAT	648.018
SIG1020 DAT	216.015

SIG1025 DAT	216.015
SIG1030 DAT	216.015

6 file 2.592.099 byte

Directory D:\prel_23

CA230600 CAL	305
P123011 DAT	1.244.586
P1230110 DAT	1.428.084
P1230111 DAT	1.241.911
P1230112 DAT	1.235.416
P1230113 DAT	1.215.361
P1230114 DAT	1.230.112
P123012 DAT	1.241.953
P123013 DAT	1.243.508
P123014 DAT	1.241.856
P123015 DAT	1.242.934
P123016 DAT	432.012
P123017 DAT	1.253.505
P123018 DAT	1.226.274
P123019 DAT	1.177.448

15 file 16.655.265 byte

Directory D:\Test_1

H1220A MAT	22.003.400
H1220A1 DAT	1.243.075
H1220A2 DAT	1.235.451
H1220A3 DAT	1.237.323
H1220A4 DAT	1.248.335
H1220A5 DAT	1.212.646
H1220B MAT	26.612.408
H1220B1 DAT	1.207.752
H1220B2 DAT	1.211.983
H1220B3 DAT	1.264.810
H1220B4 DAT	1.217.747
H1220B5 DAT	1.176.597
H1220C MAT	29.883.400
H1220C1 DAT	1.203.304
H1220C2 DAT	1.208.100
H1220C3 DAT	1.259.666
H1220C4 DAT	1.224.138
H1220C5 DAT	1.200.603

18 file 96.850.738 byte

Directory D:\Test_2

L1220A1 DAT	1.242.958
L1220A2 DAT	1.241.248
L1220A3 DAT	1.246.683
L1220A4 DAT	1.230.385
L1220A5 DAT	1.187.904
L1220A_2 MAT	24.694.976
L1220B MAT	26.615.072
L1220B1 DAT	1.242.673
L1220B2 DAT	1.242.071
L1220B3 DAT	1.252.303
L1220B4 DAT	1.248.987
L1220B5 DAT	1.185.744

L1220C	MAT	26.922.200
L1220C1	DAT	1.241.031
L1220C2	DAT	1.246.543
L1220C3	DAT	1.250.760
L1220C4	DAT	1.247.614
L1220C5	DAT	1.187.569
L1225A	MAT	24.694.976
L1225A1	DAT	1.205.746
L1225A2	DAT	1.220.930
L1225A3	DAT	1.241.992
L1225A4	DAT	1.220.080
L1225A5	DAT	1.210.718
L1225B	MAT	26.615.072
L1225B1	DAT	1.250.162
L1225B2	DAT	1.250.794
L1225B3	DAT	1.235.262
L1225B4	DAT	1.227.017
L1225B5	DAT	1.189.423
L1225C	MAT	29.883.400
L1225C1	DAT	1.247.393
L1225C2	DAT	1.250.277
L1225C3	DAT	1.247.039
L1225C4	DAT	1.235.839
L1225C5	DAT	1.210.064
L1230A1	DAT	1.236.179
L1230A2	DAT	1.256.648
L1230A3	DAT	1.260.424
L1230A4	DAT	1.252.555
L1230A5	DAT	1.209.304
L1230A 2	MAT	24.694.976
L1230B	MAT	26.615.072
L1230B1	DAT	1.237.702
L1230B2	DAT	1.250.868
L1230B3	DAT	1.240.716
L1230B4	DAT	1.253.487
L1230B5	DAT	1.199.095
L1230C	MAT	30.421.800
L1230C1	DAT	1.237.157
L1230C2	DAT	1.250.120
L1230C3	DAT	1.249.789
L1230C4	DAT	1.261.908
L1230C5	DAT	1.196.840

54 file 296.687.545 byte

Directory D:\Test 3

H1020A	MAT	24.694.976
H1020A1	DAT	1.237.969
H1020A2	DAT	1.235.454
H1020A3	DAT	1.262.537
H1020A4	DAT	1.230.390
H1020A5	DAT	1.378.927
H1020B	MAT	26.615.072
H1020B1	DAT	1.239.068
H1020B2	DAT	1.235.849
H1020B3	DAT	1.265.184
H1020B4	DAT	1.241.277

H1020B5	DAT	952.806
H1020C	MAT	30.421.800
H1020C1	DAT	1.239.335
H1020C2	DAT	1.243.804
H1020C3	DAT	1.274.477
H1020C4	DAT	1.234.149
H1020C5	DAT	925.266
H1025A	MAT	24.694.976
H1025A1	DAT	1.242.300
H1025A2	DAT	1.249.039
H1025A3	DAT	1.238.740
H1025A4	DAT	1.214.668
H1025A5	DAT	975.291
H1025B	MAT	26.615.072
H1025B1	DAT	1.243.188
H1025B2	DAT	1.241.330
H1025B3	DAT	1.242.766
H1025B4	DAT	1.225.618
H1025B5	DAT	977.767
H1025C	MAT	30.152.600
H1025C1	DAT	1.242.252
H1025C2	DAT	1.240.768
H1025C3	DAT	1.251.617
H1025C4	DAT	1.212.482
H1025C5	DAT	935.993
H1030A	MAT	24.694.976
H1030A1	DAT	1.241.934
H1030A2	DAT	1.234.842
H1030A3	DAT	1.234.828
H1030A4	DAT	1.226.607
H1030A5	DAT	942.634
H1030B	MAT	26.615.072
H1030B1	DAT	1.241.015
H1030B2	DAT	1.237.567
H1030B3	DAT	1.236.950
H1030B4	DAT	1.215.359
H1030B5	DAT	952.032
H1030C	MAT	30.691.000
H1030C1	DAT	1.242.603
H1030C2	DAT	1.243.482
H1030C3	DAT	1.249.190
H1030C4	DAT	1.228.866
H1030C5	DAT	925.602

54 file 298.779.366 byte

Directory D:\Test 4

H1020A 1	MAT	24.694.976
H1020A 2	MAT	24.694.976
H1020A 3	MAT	24.694.976
H1020B 1	MAT	26.615.072
H1020B 2	MAT	26.615.072
H1025A 3	MAT	24.694.976
H1025B 2	MAT	26.615.072
H1030A 2	MAT	24.694.976
H1030A 3	MAT	24.694.976
H1030B 1	MAT	26.615.072
H1030B 2	MAT	26.615.072

H120A11	DAT	372.039
H120A12	DAT	368.893
H120A13	DAT	371.217
H120A14	DAT	365.099
H120A15	DAT	457.192
H120A21	DAT	374.820
H120A22	DAT	368.324
H120A23	DAT	371.118
H120A24	DAT	363.726
H120A25	DAT	390.706
H120A31	DAT	371.594
H120A32	DAT	368.139
H120A33	DAT	374.793
H120A34	DAT	364.951
H120A35	DAT	410.592
H120B11	DAT	374.002
H120B12	DAT	368.229
H120B13	DAT	384.161
H120B14	DAT	364.538
H120B15	DAT	421.595
H120B21	DAT	372.980
H120B22	DAT	368.132
H120B23	DAT	385.953
H120B24	DAT	376.758
H120B25	DAT	420.778
H125A31	DAT	371.802
H125A32	DAT	376.846
H125A33	DAT	376.749
H125A34	DAT	357.683
H125A35	DAT	400.567
H125B21	DAT	371.261
H125B22	DAT	367.696
H125B23	DAT	365.226
H125B24	DAT	368.955
H125B25	DAT	445.015
H130A21	DAT	373.718
H130A22	DAT	375.552
H130A23	DAT	363.481
H130A24	DAT	360.097
H130A25	DAT	300.082
H130A31	DAT	371.819
H130A32	DAT	366.630
H130A33	DAT	364.092
H130A34	DAT	373.751
H130A35	DAT	304.048
H130B11	DAT	371.647
H130B12	DAT	367.297
H130B13	DAT	369.019
H130B14	DAT	360.796
H130B15	DAT	350.558
H130B21	DAT	373.331
H130B22	DAT	366.726
H130B23	DAT	365.246
H130B24	DAT	372.809
H130B25	DAT	306.883

66 file 301.734.927 byte

Directory D:\

1	6.449.638
10	10.990.213
11	8.125.748
12	6.675.798
13	4.340.933
14	3.699.571
15	2.525.511
16	1.883.491
17	2.270.112
18	1.744.089
19	1.308.774
2	30.823.462
20	284.736
21	851
3	31.694.748
4	35.763.632
5	33.875.454
6	31.934.448
7	31.941.874
8	24.890.181
9	14.176.907

21 file 285.400.171 byte

File structure

File *.CAL

ASCII file containing a short description and the calibration coefficients (gain) for the water level probes

Identificaci3n del Ensayo: prove laser

Fecha del Ensayo: 4 luglio 2000

Ensayos Realizados en el canalillo

Nºmero de Sensores: 5

5.106686

5.023747

5.155642

4.85238

4.927432

File *.DAT

ASCII sequential file containing measured water level in cm

-6.170037E-02

-6.170037E-02

-6.170037E-02

-6.170037E-02

-6.170037E-02

-6.170037E-02

-6.170037E-02

-6.170037E-02

-6.170037E-02

-6.170037E-02

-6.170037E-02

-6.170037E-02

...

UPr
UCa

Measurements of breaking waves and bores through a USD velocity profiler. Annex 3

A3 - 9

L A B O R A T O R Y N O T E B O O K

=====

lunedì 26 giugno 2000

1) cambio di configurazione delle sonde di livello e nuova denominazione alle sezioni di misura della velocità.

n. totale di sonde 5.

sonda canale

wg 1	1
wg 2	2
wg 3	3
wg 4	4
wg 5	5

distanza dalla pala in m:

wg1 -> 2.5 m

wg2 -> 8.0 m (inizio fondo inclinato)

wg3 -> 13.0 m (sez. A per misure velocità DOP e LASER(?))

wg4 -> 14.2 m (sez. B ")

wg5 -> 15.35 m (sez. C ")

Il nuovo nome è: A (per A1) B (per A2) C (per A3)

2) calibrazione delle sonde: abbassamento delle sonde con spessori di 5 cm (livello iniziale 57 cm), 3 misure.

coef. err %

wg1 5.6404 0.1908 %

wg2 5.4442 0.9588 %

wg3 5.6978 0.0498 %

wg4 5.3477 0.7452 %

wg5 5.3277 0.0856 %

file relativo: ca260600 (del 26 giugno 2000)

3) riportato il livello a 40 cm. Misure di livello zero per 120 s. Files relativi:

LIV0 01 (1-2-3-4-5).dat

LIV0 01.arj (compresso)

4) generazione moto del 5 ordine (Stokes) per periodo di 2 s.

Parametri inseriti: H=.12m T=2.0s d=.4m t.acq=600s f=180Hz.

con assorbitore

Files dei livelli delle sonde: H1220A(1-2-3-4-5).dat , in relazione alla sezione A di misura di velocità.

File velocità doppler : H1220A

****PROBLEMI DI GENERAZIONE:** con i periodi 2.5 e 3.0 sec (H=12cm e d=40cm) non si puo' generare il moto al 5 ord., vanno al di fuori del range di validita'. Deve essere sistemato il programma di generazione.

=====

martedi' 27 giugno 2000

Il programma ancora non funziona. Faccio le prove con periodo 2 secondi nelle sezioni B e C.

1) calibrazione delle sonde: abbassamento delle sonde con spessori di 5 cm (livello iniziale 55 cm), 3 misure.

	coef.	err %
wg1	6.7248	0.1686 %
wg2	6.5962	0.4890 %
wg3	6.6863	0.0922 %
wg4	6.1775	0.0642 %
wg5	6.3181	0.4964 %

file relativo: ca270600 (del 27 giugno 2000).

2) riportato il livello a 40 cm. Misure di livello zero per 120 s. Files relativi:

LIV0 02 (1-2-3-4-5).dat

LIV0 02.arj (compresso)

3) Cambio sensori del Doppler:

sensori canali

4	1
5	2
6	3

Misure nella sezione B con periodo $t=2.0$ s.

parametri di generazione del moto al 5 ord.:

H=.12m T=2.0s d=.4m t.acq=600s f=180Hz.

Files dei livelli delle sonde: H1220B(1-2-3-4-5).dat , in relazione alla sezione B (sensori 4-5-6) di misura di velocita'.

File velocita' doppler : H1220B.

4) Cambio sensori del Doppler:

sensori canali

7	1
8	2
9	3

Misure nella sezione C con periodo $t=2.0$ s.

parametri di generazione del moto al 5 ord.:

H=.12m T=2.0s d=.4m t.acq=600s f=180Hz.

Files dei livelli delle sonde: H1220C(1-2-3-4-5).dat , in relazione alla sezione C (sensori 7-8-9) di misura di velocita'.

File velocita' doppler : H1220C.

5) GENERAZIONE DI UN SEGNALE LINEARE (SINUSOIDALE)

5.1) Misure di livello e di velocita' nella sezione A con periodo 3.0 s

parametri di generazione del moto lineare:

H=.12m T=3.0s d=.4m t.acq=600s f=180Hz.

con assorbitore

Oss.5.1) il frang. inizia a 13.50 m, il getto avviene sui 14.50, per cui tutta la sezione B e' interessata dal frangim. Da un foro sul fondo, a ca 14.5 m dalla pala (dove forse prima c'era una sonda di pressione) delle bolle d'aria penetrano al di sotto del fondo e poi risalgono. Le sonde wg4 e wg5 si muovono molto al passaggio dell'onda. La sezione A e' prima del frangimento. (schizzo del moto lungo il canale).

Files dei livelli sono:

L1230A(1-2-3-4-5).dat

L1230A.arj (compresso)

e delle velocita' Us-doppler:

L1230A

5.2) Misure di livello in 5 sonde e di velocita' nella sezione A con periodo 2.5 s

parametri di generazione del moto lineare:

H=.12m T=2.5s d=.4m t.acq=600s f=180Hz.

con assorbitore

Oss.5.2) il frang. inizia a 13 m (wg1), il getto avviene sui 13.40-50, cade sul sensore di pressione che pero' non e' attivo. La forma d'onda e' molto instabile, peggiore di quella con periodo 3 s.

!!!! Il livello si e' abbassato di 1 mm !!!!

forse anche per la prova precedente.

(schizzo del moto lungo il canale).

Files dei livelli sono:

L1225A(1-2-3-4-5).dat

L1225A.arj (compresso)

e delle velocita' Us-doppler:

L1225A

5.3) Misure di livello in 5 sonde e di velocita' nella sezione A, con periodo 2.0 s

parametri di generazione del moto lineare:

H=.12m T=2.0s d=.4m t.acq=600s f=180Hz.

con assorbitore

Oss.5.3) il frang. inizia intorno ai 13.20-30 m, subito dopo la sez. A; il getto avviene sui 13.80. Il moto sembra meno instabile di quello con periodo 3s e 2.5s. (schizzo del moto lungo il canale).

Files dei livelli sono:

L1220A(1-2-3-4-5).dat

L1220A.arj (compresso)

e delle velocita' Us-doppler:

L1220A !!!!!!! non riesco a leggere in cine mode: i canali impazziscono e neppure dopo aver spento e riacceso il doppler riesco a leggere il segnale. Lo salvo comunque e lo invio.

6) con LL3 copiati dal doppler i files dei segnali di velocita':

H1220A (moto generato: stokes al 5 ord.)

H1220B

H1220C

TEST1 (prove prelim del 23 giugno, moto generato: stokes al 5)

TEST2

P1230A1

L1230A (moto generato: lineare o sinusoidale)

L1225A

L1220A (* cine mode non valido)

7) trasferimento con FTP su Andromeda con la seguente struttura:

- DISK_DOP: contenuto floppy del doppler;
- PREL_23 : prove preliminari del 23 giugno
 |_veldop : velocita' di prova
- REFL_23g: prove del coeff. di riflessione (23 giugno)
- PRO_26g : prove del 26 giugno (moto stokes 5)
 |_veldop : velocita' nella sezione A per T=2s
- PRO_27gi : prove del 27 giugno (moto stokes 5)
 |_veldop : velocita' nelle sezioni B e C per T=2s
- LINEAR : generazione moto lineare (27 giugno 2000)
 |_veldop : velocita' sezione A per T=2s

mercoledì 28 giugno 2000

Il programma del giorno prevede: prove con onde sinusoidali e misure di velocità nelle sezioni B e C, per i tre periodi (2,0 s 2,5 s 3,0 s) e poi spedirle su Andromeda.

oss1: Il canale è stato svuotato completamente, pulito e riempito di nuovo. Non posso fare riprese oggi perché sono sola. Il programma non è ancora stato corretto: il criterio per individuare il range di validità è quello di Fenton, e il moto con i parametri $H=12$ cm $d=40$ cm e $T=2,5$ s cade proprio sulla curva.

1) CALIBRAZIONI: abbassamento delle sonde con spessori di 5 cm (livello iniziale 53 cm), 3 misure.

	coef.	err %
wg1	6.3206	0.0010 %
wg2	6.1995	0.1382 %
wg3	6.3406	0.3096 %
wg4	6.0070	0.3608 %
wg5	6.0787	0.3138 %

file relativo: ca280600 (del 28 giugno 2000).

riportato il livello a 40 cm

2) livello zero per 120 s.

Files relativi:

LIV0 03 (1-2-3-4-5).dat

LIV0 03.arj (compresso)

3) segnale lineare: misure di velocità nella sezione B.

$T=2,0$ s

parametri inseriti: $H=12$ cm; $T=2$ s; $prof=40$ cm; $acq=600$ s; $fr=180$ Hz;
con assorb.

Files dei livelli sono:

L1220B(1-2-3-4-5).dat

L1220B.arj (compresso)

e delle velocità Us-doppler:

L1220B

$T=2,5$ s

parametri inseriti: $H=12$ cm; $T=2,5$ s; $prof=40$ cm; $acq=600$ s; $fr=180$ Hz;
con assorb.

Files dei livelli sono:

L1225B(1-2-3-4-5).dat

L1225B.arj (compresso)

e delle velocità Us-doppler:

L1225B

oss.2 = il profilo con T=2,5 s sembra molto piu' instabile rispetto ai 2 s e ai 3 s.

oss.3 Stanno lavorando nel laboratorio di strutture e muovendo il carrello: forse le vibrazioni interferiscono.

T=3,0 s

parametri inseriti: H=12 cm; T=3,0 s; prof=40 cm; acq=600s; fr=180Hz;
con assorb.

Files dei livelli sono:

L1230B(1-2-3-4-5).dat

L1230B.arj (compresso)

e delle velocita' Us-doppler:

L1230B

4) segnale lineare e misure di velocita' nella sezione C

T=2,0 s

parametri inseriti: H=12 cm; T=2,0 s; prof=40 cm; acq=600s; fr=180Hz;
con assorb.

Files dei livelli sono:

L1220C(1-2-3-4-5).dat

L1220C.arj (compresso)

e delle velocita' Us-doppler:

L1220C

T=2,5 s

parametri inseriti: H=12 cm; T=2,5 s; prof=40 cm; acq=600s; fr=180Hz;
con assorb.

Files dei livelli sono:

L1225C(1-2-3-4-5).dat

L1225C.arj (compresso)

e delle velocita' Us-doppler:

L1225C

T=3,0 s

parametri inseriti: H=12 cm; T=3,0 s; prof=40 cm; acq=600s; fr=180Hz;
con assorb.

Files dei livelli sono:

L1230C(1-2-3-4-5).dat

L1230C.arj (compresso)

e delle velocita' Us-doppler:

L1230C

oss. 4 sulla sonda wg5 c'e' molto tracer.

oss.5 La massima risalita si nota anche al di sotto del fondo, perche' non e' perfettamente impermeabile --> onda trasmessa.

(schizzo)

livelli massimi e minimi sulle sezioni A B C

T=2.0 s H=12 cm (segnale sinusoidale)

eta_max(A)=25cm; eta_min(A)=11.5cm;

eta_max(B)=16cm; eta_min(A)=7cm;

eta_max(C)= 7cm; eta_min(C)=3cm;

frangim: inizio rottura=13.20/13.30 m - getto=13.80m

T=2.5 s H=12 cm (segnale sinusoidale)

eta_max(A)=25cm; eta_min(A)=10cm;

eta_max(B)=13cm; eta_min(A)=6.5cm;

eta_max(C)= 6cm; eta_min(C)=3cm;

frangim: inizio rottura=13m - getto=13.40/13.50m

T=3.0 s H=12 cm (segnale sinusoidale)

eta_max(A)=28cm; eta_min(A)=12cm;

eta_max(B)=13cm; eta_min(A)=6cm;

eta_max(C)= 8cm; eta_min(C)=3cm;

frangim: inizio rottura=13.50/13.60 m - getto=14.50m

oss.6 Doppler : in cine mode riesco a vedere gli ultimi risultati ma i canali impazziscono

oss.7 il livello si e' abbassato di 1 mm!!!!!!

5) passaggio dei files in rete ed invio su andromeda:

pro_28gi

sezB

L1220B*.dat (.arj)

L1225B*.dat (.arj)

L1230B*.dat (.arj)

veldop

L1220B

L1225B

L1230B

sezC

L1220C*.dat (.arj)

L1225C*.dat (.arj)

L1230C*.dat (.arj)

veldop

L1220C

L1225C

L1230C

giovedì 29 giugno

programma del giorno: riprese video

1) calibrazione: misure con spessori abbassamento di 5 cm

	coeff.	err %
wg1	6.1696	0.2995 %
wg2	6.0925	0.5391 %
wg3	6.2219	0.1545 %
wg4	5.9019	0.8639 %
wg5	5.9537	0.5617 %

!!!! non ho mai cambiato l'header delle identificazioni!!!

2) livelli zero: abbassato a 40 cm per 120s

LIV0 04 (1-2-3-4-5).dat

LIV0 04.arj

3) registrazioni video segnale lineare con $H=12$ cm e $prof = 40$ cm per periodi di 2,0 s 2,5 s e 3,0 s.

4) rifare prove con segnale sinusoidale per $H=12$ cm e $T=2$ s e $T=3$ s

PRO_29gi

livelli : L1220A*.dat L1220A.arj

L1230A*.dat L1230A.arj

velocita: L1220A_1

L1230A_1

oss.1 : qualcosa non funziona nell'assorbitore. Salvo tutto ma lo devo rifare.

venerdì 30 giugno 2000

programma del giorno: rifare le prove L1220A e L1230A

prove con $H=15$ cm e $h=40$ cm con generazione al 5 ordine

prove con $H=10$ cm e $h=37$ cm con generazione al 5 ordine

misure etamax etamin $x_{frangimento}$ e $h_{frangimento}$

1) calibrazione: misure con spessori abbassamento di 5 cm

	coef.	err %
wg1	6.1351	0.0421 %
wg2	6.0587	0.5838 %
wg3	6.1873	0.3021 %
wg4	5.8334	0.3156 %
wg5	5.9365	0.0646 %

file ca300600.cal

2) Livello zero con 40 cm di acqua nel canale per 120 secondi

LIV0 05(1-2-3-4-5).dat

LIV005.arj

3) Ripetizione generazione lineare nella sezione A

H=12 cm; T=2,0 s; acq=600 s; h=40 cm; fr=180 Hz;

con assorbitore

livelli : L1220A (1-2-3-4-5).dat

L1220A.arj

Velocita': L1220A_2

H=12 cm; T=3,0 s; acq=600 s; h=40 cm; fr=180 Hz;

con assorbitore

livelli : L1230A (1-2-3-4-5).dat

L1230A.arj

Velocita': L1230A_2

salvato tutto in PRO_30gi

|_L12_NEW

4) prova con generazione al 5 ordine.

H=15 cm; h=40 cm; fr=180 Hz; acq= 180 s;

e misure

periodo T=2.0 s

etamaxA = 23 cm; etaminA = 12 cm;

etamaxB = 13 cm; etaminB = 7 cm;

etamaxC = 6.5 cm; etaminC = 3.5 cm;

frang: 12.50 - 13 m

periodo T=2.5 s

etamaxA = 27 cm; etaminA = 12 cm;

etamaxB = 17 cm; etaminB = 6.5 cm;

etamaxC = 7 cm; etaminC = 3 cm;

frang: 12.90 - 13.30 m

periodo T=3.0 s

etamaxA = 27 cm; etaminA = 11 cm;

etamaxB = 16 cm; etaminB = 7 cm;

etamaxC = 7.5 cm; etaminC = 3 cm;

frang: 12.70 - 13.30 m

h_max(frang)=30 cm a 12.70

salvati i livelli in

PRO_30gi ---> H15_5o

5) prove generazione del 5 ordine con:

H=10 cm; prof= 37 cm; acq= 600 s ; freq. = 180 Hz

oss.5.1 :la sonda wg5 ovviamente a livello 37 non e' bagnata.

ricalibrato l'assorbitore per d= 37 cm

T=2,0 sec (H=10 cm e d=37 cm)

etamaxA= 21 cm etaminA= 9cm

etamaxB= 10 cm etaminB= 5cm

etamaxC= 2.5 cm etaminC= 1cm

frang= 12.8 - 13.20 m altezza frangente = 22.5-23 cm

T=2,5 sec (H=10 cm e d=37 cm)

etamaxA= 22 cm etaminA= 8.5cm

etamaxB= 11 cm etaminB= 4.5cm

etamaxC= 2.5-2.8 cm etaminC= 1.0cm

frang= 12.90 - 13.40 m altezza frangente = 23 cm

T=3,0 sec (H=10 cm e d=37 cm)

etamaxA= 21.5-22 cm etaminA= 9cm

etamaxB= 10 cm etaminB= 4cm

etamaxC= 3.3 cm etaminC= 1.0cm

frang= 12.98 - 13.45/50 m altezza frangente = 22.5 cm

5.1) misure di velocita' nella sezione A:

H=10 cm; d = 37 cm acq= 600 s; fr= 180Hz con assorbitore

nel doppler

sensori canali

1 1

2 2

3 3

periodo T=2,0 s

- livelli: H1020A*.dat (.arj)

- velocita: H1020A

periodo T=2,5 s

- livelli: H1025A*.dat (.arj)

- velocita: H1025A

periodo T=3,0 s

- livelli: H1030A*.dat (.arj)

- velocita: H1030A

5.2) misure di velocita' nella sezione B:

H=10 cm; d = 37 cm acq= 600 s; fr= 180Hz con assorbitore

nel doppler

sensori canali

4	1
5	2
6	3

periodo T=2,0 s

- livelli: H1020B*.dat (.arj)

- velocita: H1020B

periodo T=2,5 s

- livelli: H1025B*.dat (.arj)

- velocita: H1025B

periodo T=3,0 s

- livelli: H1030B*.dat (.arj)

- velocita: H1030B

5.3) misure di velocita' nella sezione C:

H=10 cm; d = 37 cm acq= 600 s; fr= 180Hz con assorbitore

nel doppler

sensori canali

7	1
8	2
9	3

periodo T=2,0 s

- livelli: H1020C*.dat (.arj)

- velocita: H1020C

periodo T=2,5 s

- livelli: H1025C*.dat (.arj)

- velocita: H1025C

periodo T=3,0 s

- livelli: H1030C*.dat (.arj)

- velocita: H1030C

6) trasferimento con LL3 sul computer del laboratorio:

L1220A

L1230A

H1020A H1025A H1030A

H1020B H1025B H1030B

H1020C H1025C H1030C

7) trasferimento in rete e invio su andromeda:

PRO_30gi

ca300600.cal

LIV005*.dat (.arj)

--- L12_new:

prove L1220A L1230A velocita' doppler rifatte
e livelli delle sonde

--- H15_5o : generazione del 5 ordine, livelli fatti per H=15 cm prof=40 cm
acq = 180 s.

--- H10_5 : generazione del 5 ordine

sezA : velocita' nella sez. A e relativi livelli

sezB : velocita' nella sez. B e relativi livelli

sezC : velocita' nella sez. C e relativi livelli

=====

lunedì 3 luglio 2000

programma del giorno: prove laser.

1) calibrazioni:

coef. err%

wg1 5.2167 0.3632 %

wg2 5.1372 0.5649 %

wg3 5.2921 0.2746 %

wg4 4.9960 0.9386 %

wg5 5.1246 0.1797 %

file ca030700.cal